

SIRCO PV IEC 60947-3

Load break switches for photovoltaic applications
from 100 to 3200 A, up to 1500 VDC

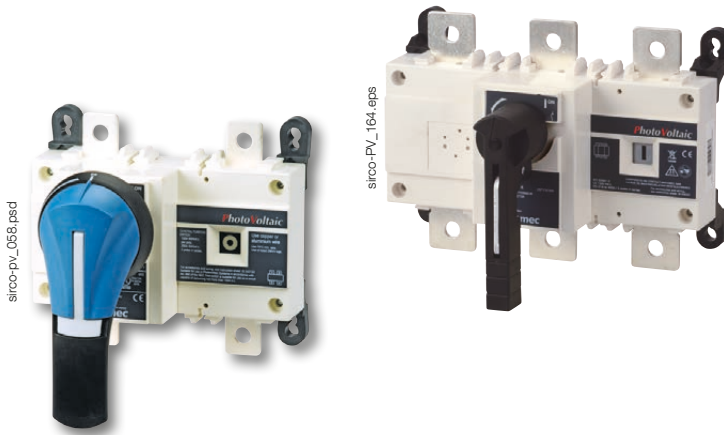

The solution for

- > Combiner box
- > Recombiner box
- > Inverter



Strong points

- > Patented switching technology up to 500 VDC/pole
- > Positive indication
- > Up to 1500 VDC according to IEC 60947-3
- > Up to 4 circuits per switch

Conformity to standards

- > IEC 60947-3
- > IEC 60364-7-712
- > UL 98B⁽¹⁾



Approvals and certifications⁽¹⁾



⁽¹⁾ Product reference on request.

Function

SIRCO PV are manually operated load break switches. Making and breaking capacity under load conditions up to 1500 VDC. These extremely durable switches have been tested and approved for use in the most demanding applications. They have been designed and tested for all types of applications: grounded, floating or bipolar.

Advantages

Optimise your investment

- Thanks to a reduced number of bridging bars, you can limit your costs and save mounting time.
- A 2 pole SIRCO PV will reduce heating and can be integrated in a smaller enclosure.

High quality materials

SIRCO PV is an extremely robust device in a glass fibre reinforced polyester frame. This material provides:

- high mechanical strength,
- stability to temperature variations (RTI of 130°C),
- high dielectric strength (high CTI / tested as per standard ASTM D 2303).

Take advantage of an innovative design

The SIRCO PV can be directly connected to up to four independent PV panel strings. The global solution cost is therefore reduced in comparison with the use of four distinct switches.

Reliability and performance

Our range of SIRCO PV load break switches is compliant to standards UL98B and IEC 60947-3.

SIRCO PV have been tested to critical currents and at a 10 kA short-circuit during 50 ms without specific protection.

Typical PV architecture

The SIRCO PV range provides safe disconnection and isolation at all levels within your PV installation.

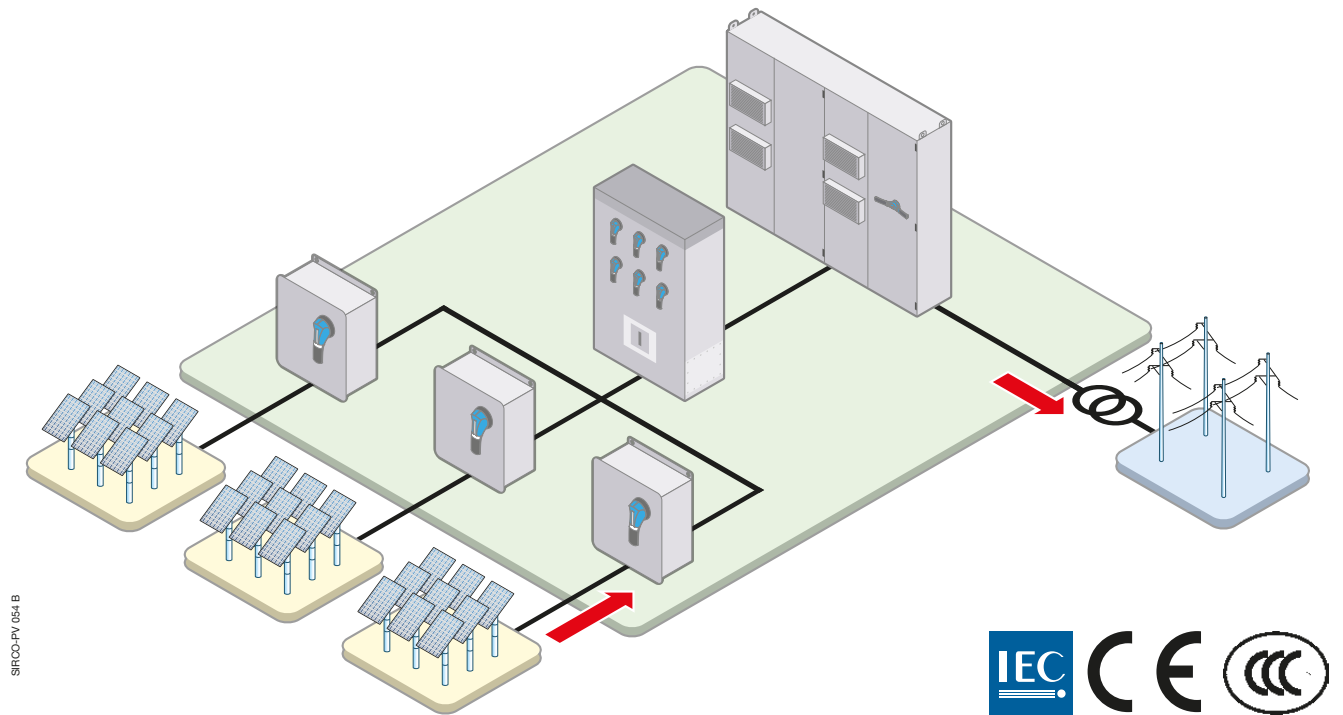

The SOCOMEC solutions

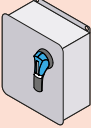
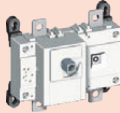
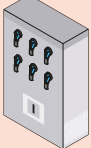
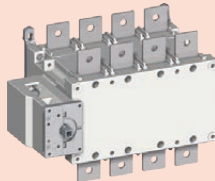
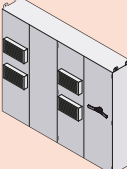
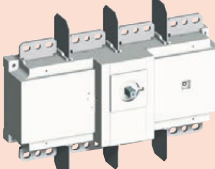
LEVEL OF INSTALLATION	SOCOMEK SOLUTIONS	
Combiner box		 SIRCO PV One circuit up to 500 A at 1500 VDC
Recombiner box		 SIRCO PV 4 circuits up to 500 A at 1000 VDC ⁽¹⁾ 2 circuits up to 500 A at 1500 VDC
Inverter		 SIRCO PV One circuit up to 3200 A at 1000 VDC up to 2000 A at 1500 VDC

(1) Please consult us.

SIRCO PV IEC 60947-3

Load break switches for photovoltaic applications
from 100 to 3200 A, up to 1500 VDC

References

1000 VDC - Back mounting

Rating (A)	Frame size	Number of poles	Switch body	Direct handle	External handle	Shaft for external handle	Quantity to be ordered to connect 2 poles in series		
1 PV circuit									
100 A	B4	2 P	26PV 2010	J1 type Black 1112 1111 Red 1113 1111	S2 type ⁽¹⁾ Black IP55 1421 2111 Black IP65 1423 2111 Red/Yellow IP65 1424 2111	200 mm 1400 1020 320 mm 1400 1032 400 mm 1400 1040	-		
160 A	B4	2 P	26PV 2016						
250 A	B4	2 P	26PV 2025						
315 A	B4	2 P	26PV 2031						
400 A	B4	4 P	26PV 4040				2 x 2609 0025		
500 A	B4	4 P	26PV 4050						
630 A	B5	4 P	26PV 4063				2 x 2709 0027		
800 A	B5	4 P	26PV 4080						
1250 A	B6	4 P	26PV 4120	J4 type Black 1142 1111 Red 1143 1111	S4 type ⁽¹⁾ Black IP65 1443 3111 Red/Yellow IP65 1444 3111	200 mm 1401 1520 320 mm 1401 1532 400 mm 1401 1520	1 x 2609 1100		
2000 A	B7	4 P	26PV 4200				2 x 2609 1200		
3200 A	B8	4 P	26PV4320				V1 type Black IP65 2799 7145	320 mm 2799 3018 450 mm 2799 3019	2 x 2609 1200
2 PV circuits									
100 A	B4 _{DS}	4 P	26PV 5010	J2 type Black 1122 1111 Red 1123 1111	S2 type ⁽¹⁾ Black IP55 1421 2111 Black IP65 1423 2111 Red/Yellow IP65 1424 2111	200 mm 1400 1020 320 mm 1400 1032 400 mm 1400 1040	-		
160 A	B4 _{DS}	4 P	26PV 5016						
250 A	B4 _{DS}	4 P	26PV 5025						
315 A	B4 _{DS}	4 P	26PV 5031						
400 A	B5	4 P	27PV 4032						
500 A	B5	4 P	27PV 4039	J1 type Black 1112 1111 Red 1113 1111					
630 A	B5 _{DS}	8 P	26PV 8063	J4 type Black 1142 1111 Red 1143 1111	S4 type ⁽¹⁾ Black IP65 1443 3111 Red/Yellow IP65 1444 3111	200 mm 1401 1520 320 mm 1401 1532 400 mm 1401 1520	2 x 2709 0027		
800 A	B6 _{DS}	8 P	26PV 8080				V1 type Black IP65 2799 7145	320 mm 4199 3018	1x 2609 1100
1250 A	B6 _{DS}	8 P	26PV 8120						1 x 2609 1200
2000 A	B7 _{DS}	8 P	26PV 8200						

(1) Defeatable handle.

1500 VDC - Back mounting

Rating (A)	Frame size	Number of poles	Switch body	Direct handle	External handle	Shaft for external handle	Quantity to be ordered to connect 2 poles in series
1 PV circuit							
160 A	B4T	3 P	26PV 3015	J1 type Black 1112 1111 Red 1113 1111	S2 type ⁽¹⁾ Black IP55 1421 2111 Black IP65 1423 2111 Red/Yellow IP65 1424 2111	200 mm 1400 1020 320 mm 1400 1032 400 mm 1400 1040	Standard bridging bar 1 x 2609 0026 Back bridging bar 1 x 2609 0041
250 A	B4T	3 P	26PV 3024				
315 A	B4T	3 P	26PV 3030				
400 A	B4T	3 P	26PV 3039				
500 A	B5	3 P	26PV 3051	J2 type Black 1122 1111 Red 1123 1111	S2 type ⁽¹⁾ Black IP55 1421 2111 Black IP65 1423 2111 Red/Yellow IP65 1424 2111	200 mm 1400 1020 320 mm 1400 1032 400 mm 1400 1040	2 x 2609 0027
630 A	B5	4 P	26PV 4064				4x 2609 0027
800 A	B6 _{DS}	8 P	26PV 8080	J4 type Black 1142 1111 Red 1143 1111	V1 type Black IP65 2799 7145	320 mm 4199 3018	1 x 2609 1100
1250 A	B6 _{DS}	8 P	26PV 8120				1x 2609 1200
2000 A	B7 _{DS}	8 P	26PV 8200				
2 PV circuits							
315 A	B5 _{DS}	6 P	26PV 6032	J4 type Black 1142 1111 Red 1143 1111	S4 type ⁽¹⁾ Black IP65 1443 3111 Red/Yellow IP65 1444 3111	200 mm 1401 1520 320 mm 1401 1532 400 mm 1401 1520	1 x 2609 0027
400 A	B5 _{DS}	6 P	26PV 6042				2 x 2709 0027
500 A	B5 _{DS}	6 P	26PV 6052				4 x 2609 0027
630 A	B5 _{DS}	8 P	26PV 8064				

(1) Defeatable handle.

NOTE: For configurations requesting more than 2 PV circuits, please consult your usual contact.

Accessories

Direct operation handle

Frame size	Handle type	Handle colour	Reference
B4 ... B5	B2	Black	2699 5052
		Red	2699 5053
	J1	Black	1112 1111
		Red	1113 1111
B6 ... B7	J4	Black	1142 1111
		Red	1143 1111
	B2	Black	2699 5052
		Red	2699 5053
B4 _{DS} ... B5 _{DS}	J4	Black	1142 1111
		Red	1143 1111
	J2	Black	1122 1111
		Red	1123 1111
	J4	Black	1142 1111
		Red	1143 1111
B6 _{DS} ...B7 _{DS}	J4	Black	1142 1111
		Red	1143 1111
B8	J4	Black	1142 1111
		Red	1143 1111



SIRCO PV IEC 60947-3

Load break switches for photovoltaic applications

from 100 to 3200 A, up to 1500 VDC

Accessories (continued)

Door interlocked external operation handle

Use

Door interlocked external operation handles include an escutcheon, are padlockable and must be utilised with an extension shaft.

In a combiner box, located close to the solar cell strings, or located close to the inverter, we recommend to use a door interlocked external handle for its safety features.

Example

The locking function of the enclosure in the "ON" position will force the operator to safely disconnect and isolate the solar cell strings prior to any intervention.

Opening the door when the switch is on "ON" position is possible by defeating the locking function using a tool (authorised persons only). The interlocking function is restored when the door is re-closed.

Frame size	Handle type	Handle colour	Degree of protection	Reference
B4 ... B5	S2	Black	IP55	1421 2111
	S2	Black	IP65	1423 2111
	S2	Red/ Yellow	IP65	1424 2111
B6 ... B7	S4	Black	IP65	1443 3111
	S4	Red/ Yellow	IP65	1444 3111
B8	V1	Black	IP65	2799 7145
B4 _{DS}	S2	Black	IP55	1421 2111
	S2	Black	IP65	1423 2111
	S2	Red/ Yellow	IP65	1424 2111
B5 _{DS}	S4	Black	IP65	1443 3111
	S4	Red/ Yellow	IP65	1444 3111
B6 _{DS} ... B7 _{DS} B8	V1	Black	IP65	2799 7145



Shaft for external handle

Use

Standard lengths:

- 200 mm,
- 320 mm,
- 400 mm.

Other lengths: Please consult us.

Frame size	Handle type	Dimensions X (mm)	Length (mm)	Reference
B4	S2	150 ... 295	200	1400 1020
B4	S2	150 ... 415	320	1400 1032
B4	S2	150 ... 495	400	1400 1040
B5	S2	203 ... 328	200	1400 1020
B5	S2	203 ... 448	320	1400 1032
B5	S2	203 ... 525	400	1400 1040
B6	S4	220 ... 343	200	1401 1520
B6	S4	220 ... 463	320	1401 1532
B6	S4	220 ... 543	400	1401 1540
B7	S4	305 ... 366	200	1401 1520
B7	S4	305 ... 485	320	1401 1532
B7	S4	305 ... 564	400	1401 1540
B8	V1	415 ... 690	320	2799 3018
B8	V1	415 ... 820	450	2799 3019
B4 _{DS}	S2	210...310	200	1400 1020
B4 _{DS}	S2	210...430	320	1400 1032
B4 _{DS}	S2	210...510	400	1400 1040
B5 _{DS}	S4	280...390	200	1401 1520
B5 _{DS}	S4	280...510	320	1401 1532
B5 _{DS}	S4	280...590	400	1401 1540
B6 _{DS}	V1	425...577	320	4199 3018
B6 _{DS}	V1	425...697	400	4199 3019
B7 _{DS}	V1	425...697	320	4199 3018
B7 _{DS}	V1	425...777	400	4199 3019

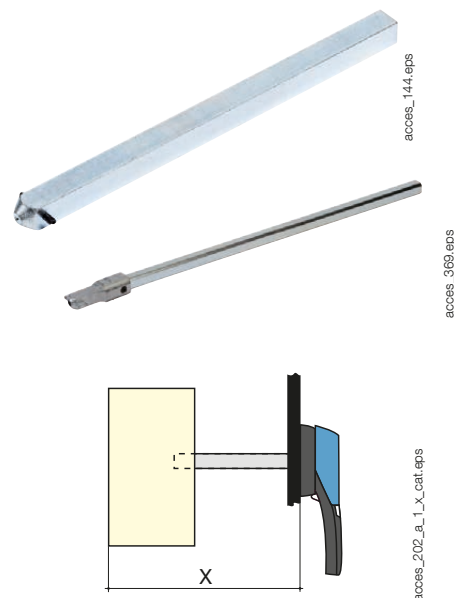

Shaft guide for external operation

Use

To guide the shaft extension into the external handle.

This accessory enables the handle to engage the extension shaft with a misalignment of up to 15 mm.

Required for a shaft length over 320 mm.



access_260_a_2_cat

Description	Reference
Shaft guide	1429 0000

S-type handle adapter

Use

Enables S-type handles to be fitted in place of existing older style Socomec handles.

Adapter can also be utilised as a spacer to increase the distance between the panel door and the handle lever.

Dimensions

Adds 12 mm to the depth of the handle.



access_187

Handle colour	External IP ⁽¹⁾	To be ordered in multiples of	Reference
Black	IP65	1	1493 0000

(1) IP: protection degree according to IEC 60529 standard.

Alternative S-type handle cover colours

Use

For single lever handles type S1, S2, S3.

Other colours: Please consult us.

Handle colour	Handle type	To be ordered in multiples of	Reference
Light grey	S1, S2, S3	50	1401 0001
Dark grey	S1, S2, S3	50	1401 0011
Light grey	S4	50	1401 0031
Dark grey	S4	50	1401 0041



access_198.eps

Auxiliary contact

Use

Pre-break and signalling of positions 0 and I:

- 1 to 2 NO/NC auxiliary contacts,
- 1 to 4 NO + NC auxiliary contacts,
- 1 to 2 low level NO/NC auxiliary contacts.

Characteristics

NO/NC AC: IP2 with front operation.

Connection to the control circuit

By 6.35 mm fast-on terminal.

Electrical characteristics

30 000 operations.

NO/NC changeover auxiliary contacts

Frame size	Position AC	Type	Reference
B4 ... B8	1 contact	NO/NC	2699 0031
B4 ... B8	2 contacts	NO/NC	2699 0032
B4 _{DS} ... B7 _{DS}	1 contact	NO/NC	2699 0061
B4 _{DS} ... B7 _{DS}	2 contacts	NO/NC	2699 0062

Low level NO/NC auxiliary contacts

Frame size	Position AC	Type	Reference
B4 ... B7	1 contact	NO/NC	2699 0301
B4 ... B7	2 contacts	NO/NC	2699 0302

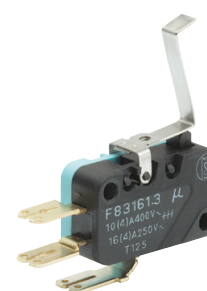

access_076.eps

SIRCO PV IEC 60947-3

Load break switches for photovoltaic applications

from 100 to 3200 A, up to 1500 VDC

Accessories (continued)

Terminal screen

Use

Top and bottom protection against direct contact with terminals or connection parts.

Frame size	No. of poles	Position	Pack	Reference
B4	2 P	Top or bottom	1 unit	2698 3020
B4T	3 P	Top or bottom	1 unit	2698 4020
B4	4 P	Top or bottom	1 unit	2698 4020
B5	3 P	Top or bottom	1 unit	2698 3050
B5	4 P	Top or bottom	1 unit	2698 4050
B6	4 P	Top or bottom	1 unit	2698 4080
B7	4 P	Top or bottom	1 unit	2698 4120
B8	4 P	Top or bottom	1 unit	2698 4200
B4 _{DS}	2 P	Top or bottom	1 unit	1509 3025
B5 _{DS}	6 P	Top and bottom	2 units	1509 3063
B5 _{DS}	8 P	Top and bottom	2 units	1509 4063
B6 _{DS}	8 P	Top and bottom	2 units	1509 4080



access_079.eps

Inter-phase barrier

Use

Safe isolation between the terminals.

Frame size	No. of poles	Reference
B4	2 P	2998 0023
B4T	3 P	2998 0023
B4	4 P	2998 0024
B5	2/3 P	2998 0013
B5	4 P	2998 0014
B6...B8	3 P	Included
B6...B8	4 P	Included

The inter-phase barriers are not mandatory but we recommend to separate the polarities + and -.







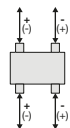

Accessories (continued)

Bridging bars for connecting poles in series

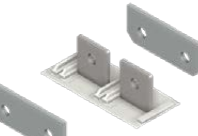
Use

The bridging bars will make easy the connection of the poles in series, allowing the following configurations⁽¹⁾.

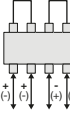
⁽¹⁾ Other connections: refer to mounting instructions.

1000 VDC - 1 independent PV circuit							
Switch body Reference	Rating (A)	Frame size	Quantity to be ordered to connect 2 poles in series	Fig.	Quantity of bridging bars kits to order per switch - ungrounded	Fig.	Reference
26PV 2010	100	B4	N/A		N/A		-
26PV 2016	160	B4	N/A		N/A		
26PV 2025	250	B4	N/A		N/A		
26PV 2031	315	B4	N/A		N/A		
26PV 4040	400	B4	2		4		2609 0025
26PV 4050	500	B4	2		4		2609 0025
26PV 4063	630	B5	2		4		2709 0027
26PV 4080	800	B5	2		4		2709 0027
26PV 4120	1250	B6	1		2		2609 1100
26PV 4200	2000	B7	1		2		2609 1200
26PV 4320	3200	B8	1		2		

SIRCO PV IEC 60947-3

Load break switches for photovoltaic applications
from 100 to 3200 A, up to 1500 VDC

Accessories (continued)





Bridging bars for connecting poles in series (continued)

Use

The bridging bars will make easy the connection of the poles in series, allowing the following configurations⁽¹⁾.

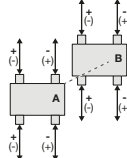
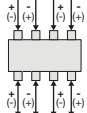
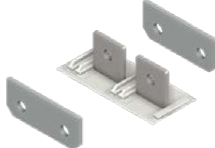
⁽¹⁾ Other connections: refer to mounting instructions.

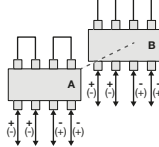
1000 VDC - 2 independents PV circuits

Switch body Reference	Rating (A)	Frame size	Quantity to be ordered to connect 2 poles in series	Fig.	Quantity of bridging bars kits to order per switch - ungrounded	Fig.	Reference
26PV 5010	100	B4 _{DS}	N/A		N/A		
26PV 5016	160	B4 _{DS}	N/A		N/A		
26PV 5025	250	B4 _{DS}	N/A		N/A		
26PV 5031	315	B4 _{DS}	N/A		N/A		
27PV 4032	400	B5	N/A		N/A		
27PV 4039	500	B5	N/A		N/A		
26PV 8063	630	B5 _{DS}	2		8		2709 0027
26PV 8080	800	B6 _{DS}	1		4		2609 1100
26PV 8120	1250	B6 _{DS}	1		4		2609 1100
26PV 8200	2000	B7 _{DS}	1		4		2609 1200





Bridging bars for connecting poles in series (continued)

Use

The bridging bars will make easy the connection of the poles in series, allowing the following configurations⁽¹⁾.

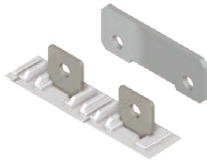
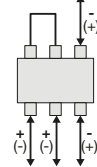
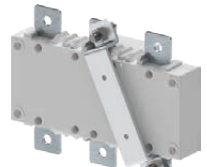
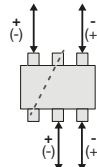
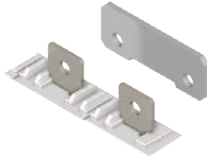
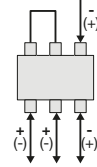
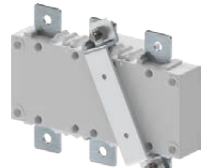
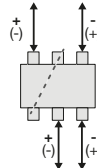
⁽¹⁾ Other connections: refer to mounting instructions.

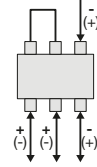
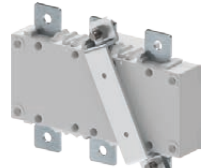
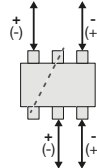
1500 VDC - 1 independent PV circuit

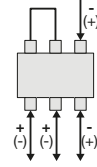
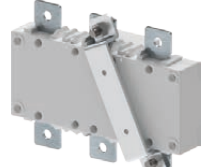
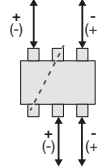
Switch body Reference	Rating (A)	Frame size	Quantity to be ordered to connect 2 poles in series	Fig.	Quantity of bridging bars kits to order per switch - ungrounded	Fig.	Reference
26PV 3015	160	B4T	1		1		2609 0026
							2609 0041
26PV 3024	250	B4T	1		1		2609 0026
							2609 0041
26PV 3030	315	B4T	1		1		2609 0026
							2609 0041
26PV 3039	400	B4T	1		1		2609 0026
							2609 0041

SIRCO PV IEC 60947-3

Load break switches for photovoltaic applications
from 100 to 3200 A, up to 1500 VDC

Accessories (continued)

Bridging bars for connecting poles in series (continued)

Use

The bridging bars will make easy the connection of the poles in series, allowing the following configurations⁽¹⁾.

⁽¹⁾ Other connections: refer to mounting instructions.

1500 VDC - 1 independent PV circuit							
Switch body Reference	Rating (A)	Frame size	Quantity to be ordered to connect 2 poles in series	Fig.	Quantity of bridging bars kits to order per switch - ungrounded	Fig.	Reference
26PV 3051	500	B5	2		2		2609 0027
26PV 4064	630	B5	2		4		2609 0027
26PV 8080	800	B6 _{DS}	1		4		2609 1100
26PV 8120	1250	B6 _{DS}	1		4		2609 1100
26PV 8200	2000	B7 _{DS}	1		4		2609 1200
1500 VDC - 2 independents PV circuits							
26PV 6026	275	B5 _{DS}	1		2		2609 0027
26PV 6032	315	B5 _{DS}	1		2		2609 0027
26PV 6042	400	B5 _{DS}	1		2		2609 0027
26PV 6052	500	B5 _{DS}	2		4		2609 0027
26PV 8064	630	B5 _{DS}	2		8		2609 0027

Characteristics

Characteristics according to IEC 60947-3

Rated Current I_n			100 A		160 A			250 A			
Reference			26PV 2010	26PV 5010	26PV 2016	26PV 5016	26PV 3015	26PV 2025	26PV 5025	26PV 3024	
Frame size			B4	B4 _{DS}	B4	B4 _{DS}	B4T	B4	B4 _{DS}	B4T	
Thermal current at 40°C (A)			100	100	160	160	160	250	250	250	
Thermal current at 45°C (A)			100	100	160	160	160	250	250	250	
Thermal current at 50°C (A)			100	100	160	160	160	250	250	250	
Thermal current at 55°C (A)			100	100	160	160	160	250	250	250	
Thermal current at 60°C (A)			100	100	160	160	160	250	250	250	
Thermal current at 65°C (A)			100	100	160	160	152	250	250	237	
Thermal current at 70°C (A)			100	100	160	160	144	250	250	225	
Rated insulation voltage U_i (V)			1500	1500	1500	1500	1500	1500	1500	1500	
Rated impulse withstand voltage U_{imp} (kV)			12	12	12	12	12	12	12	12	
Number of circuits	Rated voltage	Utilisation category	I_e (A)		I_e (A)			I_e (A)			
			I_e (A)	I_e (A)	I_e (A)	I_e (A)	I_e (A)	I_e (A)	I_e (A)	I_e (A)	
I_e (A)	1 circuit	1000 VDC	DC-21 B	100	-	160	-	-	250	-	-
	2 circuits			-	100	-	160	-	-	250	-
	1 circuit	1500 VDC	DC-21 B	-	-	-	-	-	-	-	
	2 circuits			-	-	-	-	-	-	-	
1 circuit		DC-PV1	-	-	-	-	250	-	-	250	
Number of pole(s) in series per circuit			1P+; 1P- ⁽¹⁾	1P+; 1P- ⁽²⁾	1P+; 1P- ⁽¹⁾	1P+; 1P- ⁽²⁾	2P+; 1P- ⁽³⁾	1P+; 1P- ⁽¹⁾	1P+; 1P- ⁽²⁾	2P+; 1P- ⁽³⁾	
Number of pole(s) of the device			2 P	4 P	2 P	4 P	3 P	2 P	4 P	3 P	
Short-circuit capacity (without protection)											
Rated short-time withstand current 0.3 s. (kA eff)			10	10	10	10	10	10	10	10	
Rated short-time withstand current 1 s. (kA eff)			5	5	5	5	5	5	5	5	
Power dissipation per poles of the PV switch (W/P) @ 40°C			0.8	0.8	2	2	2.5	4.7	4.7	5	
Humidity according to IEC 60947-1 Annex Q (%)			95	95	95	95	95	95	95	95	
Connection											
Nominal Cu cable section (mm ²)			35	35	70	70	70	120	120	120	
Maximum Cu rigid cable cross-section (mm ²)			-	-	-	-	-	-	-	-	
Nominal Cu busbar width (mm)			32	32	32	32	32	32	32	32	
Maximum Cu busbar width (mm)			-	-	-	-	-	-	-	-	

(1)

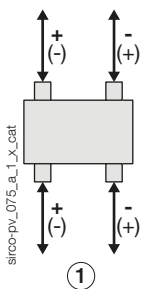

1. Utility 1
2. Utility 2

(2)

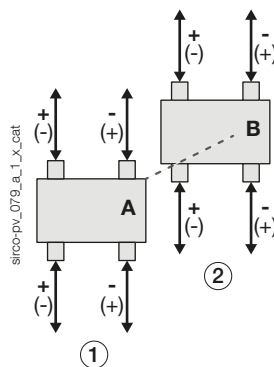

(3)

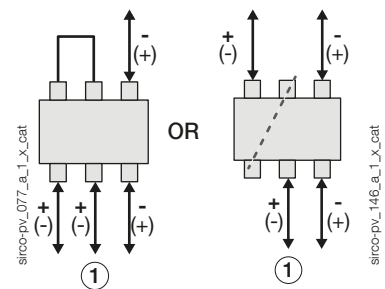

SIRCO PV IEC 60947-3

Load break switches for photovoltaic applications

from 100 to 3200 A, up to 1500 VDC

Characteristics (continued)

Characteristics according to IEC 60947-3

Rated Current I_n				275 A		315 A		
Reference				26PV 6026	26PV 2031	26PV 5031	26PV 3030	26PV 6032
Frame size				B5_{DS}	B4	B4_{DS}	B4T	B5_{DS}
Thermal current at 40°C (A)				275	315	315	315	315
Thermal current at 45°C (A)				275	315	315	315	315
Thermal current at 50°C (A)				275	315	315	315	315
Thermal current at 55°C (A)				275	315	315	315	315
Thermal current at 60°C (A)				275	315	315	315	315
Thermal current at 65°C (A)				275	315	315	299	315
Thermal current at 70°C (A)				275	315	315	283	315
Rated insulation voltage U_i (V)				1500	1500	1500	1500	1500
Rated impulse withstand voltage U_{imp} (kV)				12	12	12	12	12
I_e (A)	Number of circuits		Rated voltage	Utilisation category	I_e (A)	I_e (A)	I_e (A)	I_e (A)
	1 circuit	2 circuits	1000 VDC	DC-21 B	-	315	-	-
					-	-	315	-
	2 circuits	1 circuit	1500 VDC	DC-21 B	-	-	-	-
					275	-	-	315
1 circuit			DC-PV1	-	-	315	-	
Number of pole(s) in series per circuit				2P+; 1P-(²)	1P+; 1P-(³)	1P+; 1P-(⁴)	2P+; 1P-(⁵)	2P+; 1P-(²)
Number of pole(s) of the device				6 P	2 P	4 P	3 P	6 P
Short-circuit capacity (without protection)								
Rated short-time withstand current 0.3 s. (kA eff)				10	10	10	10	10
Rated short-time withstand current 1 s. (kA eff)				5	5	5	5	5
Power dissipation per poles of the PV switch (W/P) @ 40°C				-	8	8	9.5	-
Humidity according to IEC 60947-1 Annexe Q (%)				95	95	95	95	95
Connection								
Nominal Cu cable section (mm ²)				85	185	185	185	185
Maximum Cu rigid cable cross-section (mm ²)				-	-	-	-	-
Nominal Cu busbar width (mm)				32	32	32	32	32
Maximum Cu busbar width (mm)				-	-	-	-	-

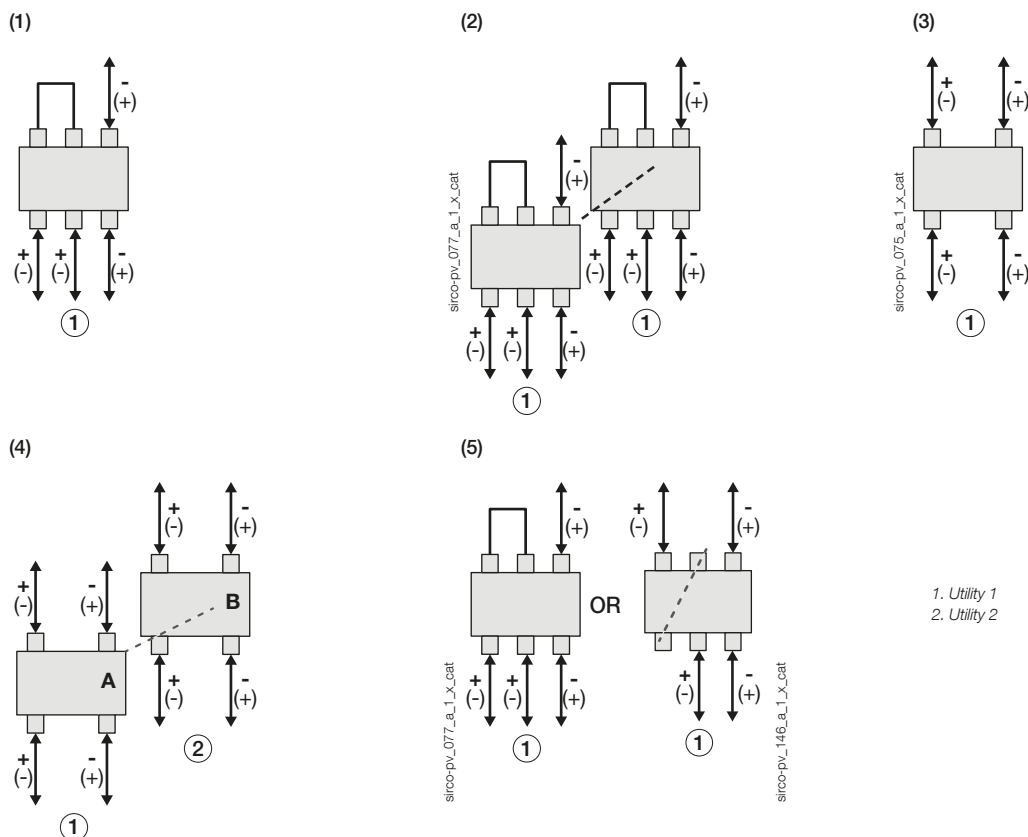

Characteristics according to IEC 60947-3

Rated Current I_n			400 A			
Reference			26PV 4040	27PV 4032	26PV 3039	26PV 6042
Frame size			B4	B5	B4T	B5_{DS}
Thermal current at 40°C (A)			400	400	400	400
Thermal current at 45°C (A)			400	400	400	TBC
Thermal current at 50°C (A)			400	400	400	TBC
Thermal current at 55°C (A)			400	400	400	TBC
Thermal current at 60°C (A)			400	400	400	TBC
Thermal current at 65°C (A)			380	400	380	TBC
Thermal current at 70°C (A)			360	400	360	TBC
Rated insulation voltage U_i (V)			1500	1500	1500	1500
Rated impulse withstand voltage U_{imp} (kV)			12	12	12	12
Number of circuits	Rated voltage	Utilisation category	I_e (A)	I_e (A)	I_e (A)	I_e (A)
I_e (A)	1 circuit	1000 VDC	400	-	-	-
	2 circuits		-	400	-	-
	1 circuit	1500 VDC	-	-	-	-
	2 circuits		-	-	-	400
	1 circuit		-	-	400	-
Number of pole(s) in series per circuit			2P+; 2P- ⁽¹⁾	1P+; 1P- ⁽²⁾	2P+; 1P- ⁽³⁾	2P+; 1P- ⁽⁵⁾
Number of pole(s) of the device			4 P	4 P	3 P	6 P
Short-circuit capacity (without protection)						
Rated short-time withstand current 0.3 s. (kA eff)			10	10	10	10
Rated short-time withstand current 1 s. (kA eff)			5	5	5	5
Power dissipation per poles of the PV switch (W/P) @ 40°C			20	12.7	15	12.7
Humidity according to IEC 60947-1 Annexe Q (%)			95	95	95	95
Connection						
Nominal Cu cable section (mm ²)			240	240	240	240
Maximum Cu rigid cable cross-section (mm ²)			-	-	-	-
Nominal Cu busbar width (mm)			32	40	32	32
Maximum Cu busbar width (mm)			-	-	-	-

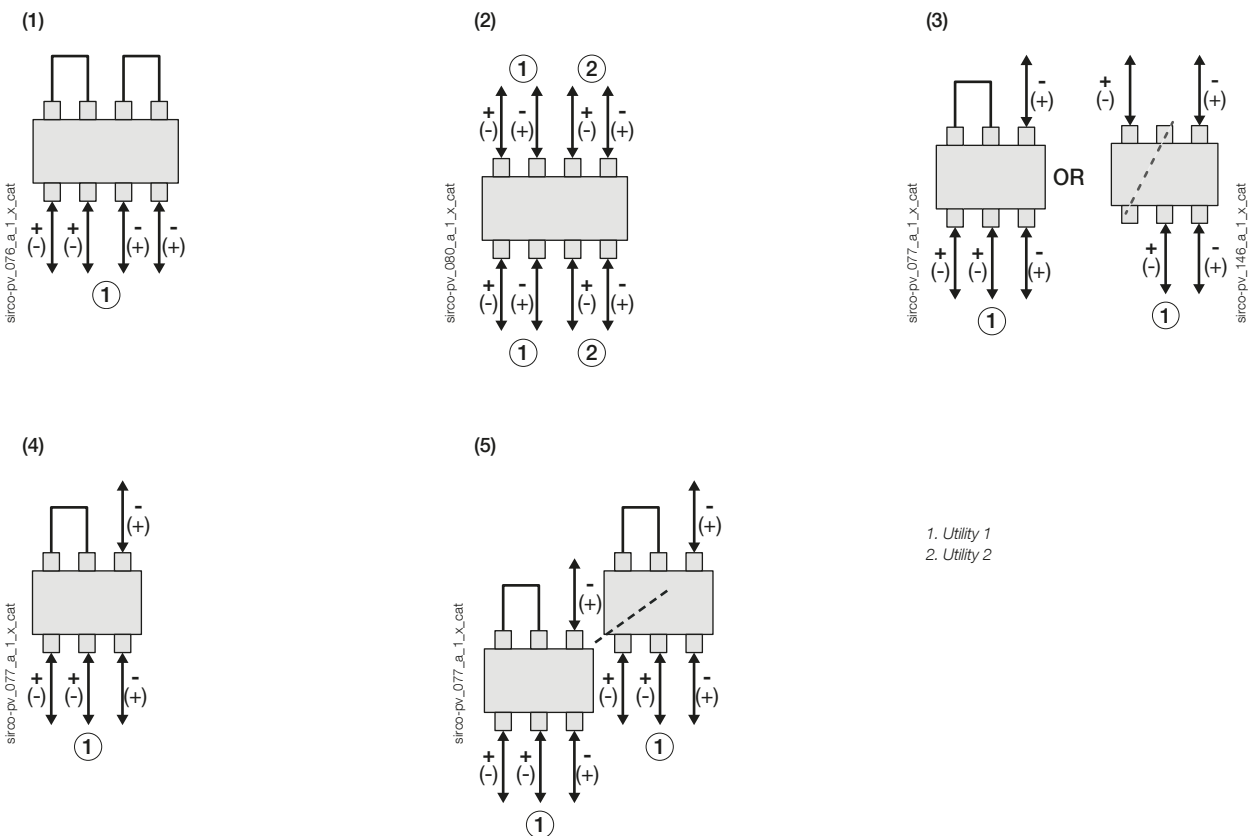

SIRCO PV IEC 60947-3

Load break switches for photovoltaic applications

from 100 to 3200 A, up to 1500 VDC

Characteristics (continued)

Characteristics according to IEC 60947-3

Rated Current I_n				500 A			
Reference				26PV 4050	27PV 4039	26PV 3051	26PV 6052
Frame size				B4	B5	B5	B5 _{DS}
Thermal current at 40°C (A)				500	500	500	500
Thermal current at 45°C (A)				500	500	500	500
Thermal current at 50°C (A)				500	500	500	500
Thermal current at 55°C (A)				500	500	500	500
Thermal current at 60°C (A)				500	500	500	500
Thermal current at 65°C (A)				500	475	460	460
Thermal current at 70°C (A)				500	450	420	420
Rated insulation voltage U_i (V)				1500	1500	1500	1500
Rated impulse withstand voltage U_{imp} (kV)				12	12	12	12
Number of circuits		Rated voltage	Utilisation category	I_e (A)	I_e (A)	I_e (A)	I_e (A)
I_e (A)	1 circuit	1000 VDC	DC-21 B	500	-	-	-
	2 circuits			-	500	-	-
	1 circuit	1500 VDC	DC-21 B	-	-	500	-
	2 circuits			-	-	-	500
Number of pole(s) in series per circuit				2P+; 2P- ⁽¹⁾	1P+; 1P- ⁽²⁾	2P+; 1P- ⁽³⁾	2P+; 1P- ⁽⁴⁾
Number of pole(s) of the device				4 P	4 P	3 P	6 P
Short-circuit capacity (without protection)							
Rated short-time withstand current 0.3 s. (kA eff)				10	10	10	10
Rated short-time withstand current 1 s. (kA eff)				5	5	5	5
Power dissipation per poles of the PV switch (W/P) @ 40°C				30	-	19	19
Humidity according to IEC 60947-1 Annexe Q (%)				95	95	95	95
Connection							
Nominal Cu cable section (mm ²)				2 x 150	2 x 150	2 x 150	2 x 150
Maximum Cu rigid cable cross-section (mm ²)				-	-	-	-
Nominal Cu busbar width (mm)				32	40	32	32
Maximum Cu busbar width (mm)				-	-	-	-

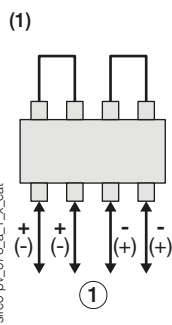

1. Utility 1
2. Utility 2

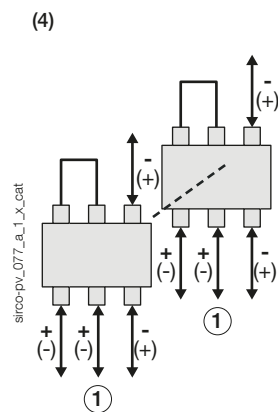
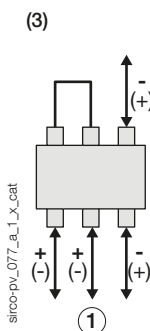
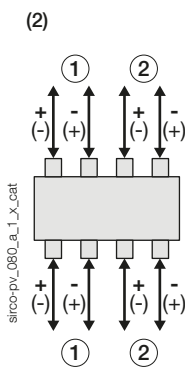

Characteristics according to IEC 60947-3

Rated Current I_n				630 A				800 A	
Reference				26PV 4063	26PV 8063	26PV 4064	26PV 8064	26PV 4080	26PV 8080
Frame size				B5	B5 _{DS}	B5	B5 _{DS}	B5	B5 _{DS}
Thermal current at 40°C (A)				630	630	630	630	800	800
Thermal current at 45°C (A)				630	630	TBC	TBC	760	760
Thermal current at 50°C (A)				630	630	TBC	TBC	720	720
Thermal current at 55°C (A)				630	630	TBC	TBC	685	685
Thermal current at 60°C (A)				560	560	TBC	TBC	650	650
Thermal current at 65°C (A)				540	540	TBC	TBC	620	620
Thermal current at 70°C (A)				510	510	TBC	TBC	590	590
Rated insulation voltage U_i (V)				1500	1500	1500	1500	1200	1500
Rated impulse withstand voltage U_{imp} (kV)				12	12	12	12	12	12
Number of circuits	Rated voltage	Utilisation category	I_e (A)	I_e (A)	I_e (A)	I_e (A)	I_e (A)	I_e (A)	I_e (A)
I_e (A)	1 circuit	1000 VDC	DC-21 B	630	-	-	-	800	-
	2 circuits			-	630	-	-	-	800
	1 circuit	1500 VDC	DC-21 B	-	-	630	-	-	800
	2 circuits			-	-	630	-	-	-
Number of pole(s) in series per circuit				2P+; 2P- ⁽¹⁾	2P+; 2P- ⁽²⁾	2P+; 2P- ⁽³⁾	2P+; 2P- ⁽²⁾	2P+; 2P- ⁽¹⁾	2P+; 2P- ⁽²⁾ 4P+; 4P- ⁽⁴⁾
Number of pole(s) of the device				4 P	8 P	4 P	8 P	4 P	8 P
Short-circuit capacity (without protection)									
Rated short-time withstand current 0.3 s. (kA eff)				10	10	10	10	10	10
Rated short-time withstand current 1 s. (kA eff)				5	5	5	5	5	5
Power dissipation per poles of the PV switch (W/P) @ 40°C				40	40	-	-	70	70
Humidity according to IEC 60947-1 Annexe Q (%)				95	95	95	95	95	95
Connection									
Nominal Cu cable section (mm ²)				2 x 185	2 x 185	-	-	2 x 240	2 x 240
Maximum Cu rigid cable cross-section (mm ²)				-	-	-	-	-	-
Nominal Cu busbar width (mm)				40	40	-	-	50	50
Maximum Cu busbar width (mm)				-	-	-	-	-	-

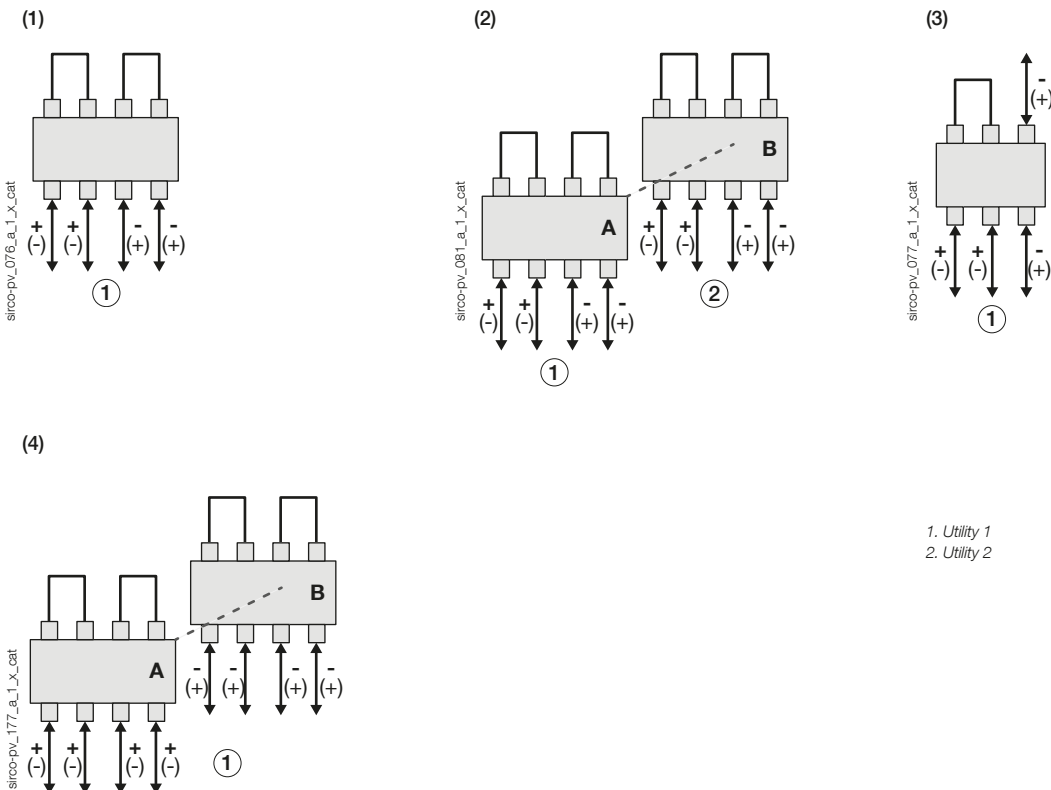

Characteristics (continued)

Characteristics according to IEC 60947-3

Rated Current I_n			1250 A			2000 A			3200 A
Reference			26PV 4120	26PV 8120		26PV 4200	26PV 8200		26PV 4320
Frame size			B6	B6 _{DS}		B7	B7 _{DS}		B8
Thermal current at 40°C (A)			1250	1250		2000	2000		3200
Thermal current at 45°C (A)			1250	1250		2000	2000		3200
Thermal current at 50°C (A)			1250	1250		1850	1850		3200
Thermal current at 55°C (A)			1180	1180		1730	1730		3040
Thermal current at 60°C (A)			1125	1125		1600	1600		2888
Thermal current at 65°C (A)			1050	1050		1520	1520		2743
Thermal current at 70°C (A)			1000	1000		1440	1440		2606
Rated insulation voltage U_i (V)			-	-		1500	1500		1500
Rated impulse withstand voltage U_{imp} (kV)			12	12		12	12		12
I_e (A)	Number of circuits	Rated voltage	Utilisation category	I_e (A)	I_e (A)	I_e (A)	I_e (A)	I_e (A)	I_e (A)
	1 circuit	1000 VDC	DC-21 B	1250	-	-	2000	-	3200
2 circuits	-			1250	-	-	2000	-	-
I_e (A)	1 circuit	1500 VDC	DC-21 B	-	-	1250	-	2000	-
	2 circuits			-	-	-	-	-	-
Number of pole(s) in series per circuit			2P+; 2P- ⁽¹⁾	2P+; 2P- ⁽²⁾	4P+; 4P- ⁽³⁾	2P+; 2P- ⁽¹⁾	2P+; 2P- ⁽²⁾	4P+; 4P- ⁽³⁾	4P+; 4P- ⁽¹⁾
Number of pole(s) of the device			4 P	8 P		4 P	8 P		4 P
Short-circuit capacity (without protection)									
Rated short-time withstand current 0.3 s. (kA eff)			10	10		10	10		10
Rated short-time withstand current 1 s. (kA eff)			5	5		5	5		5
Power dissipation per poles of the PV switch (W/P) @ 40°C			-	63		-	125		-
Humidity according to IEC 60947-1 Annexe Q (%)			95	95		95	95		95
Connection									
Nominal Cu cable section (mm ²)			2 x 240	2 x 240		-	-		-
Maximum Cu rigid cable cross-section (mm ²)			-	-		-	-		-
Nominal Cu busbar width (mm)			63	63		100	100		4 x 100 x 5
Maximum Cu busbar width (mm)			-	-		-	-		-

(1)

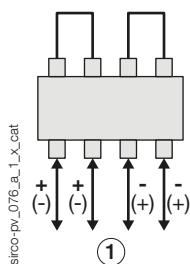

1. Utility 1
2. Utility 2

(2)

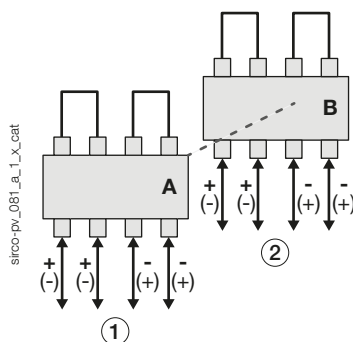

(3)

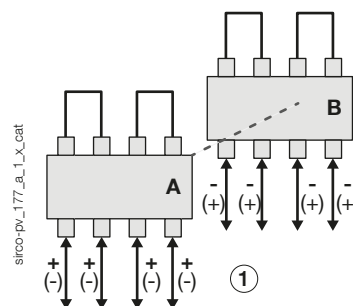

Dimensions (mm)

100 to 315 A - B4 - 2P - 1000 VDC - 1 circuit

26PV 2010 - 26PV 2016 - 26PV 2025 - 26PV 2031

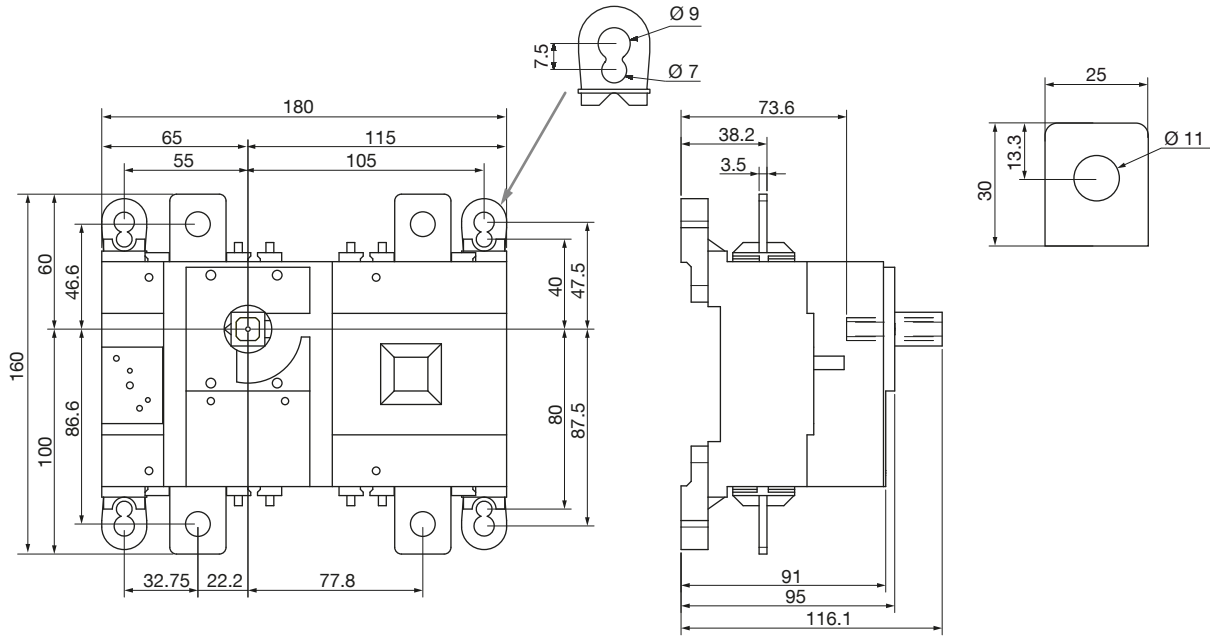

sirco-pv_141_a_1_x_cat.ital

400 to 500 A - B4 - 4P - 1000 VDC - 1 circuit

26PV 4040 - 26PV 4050

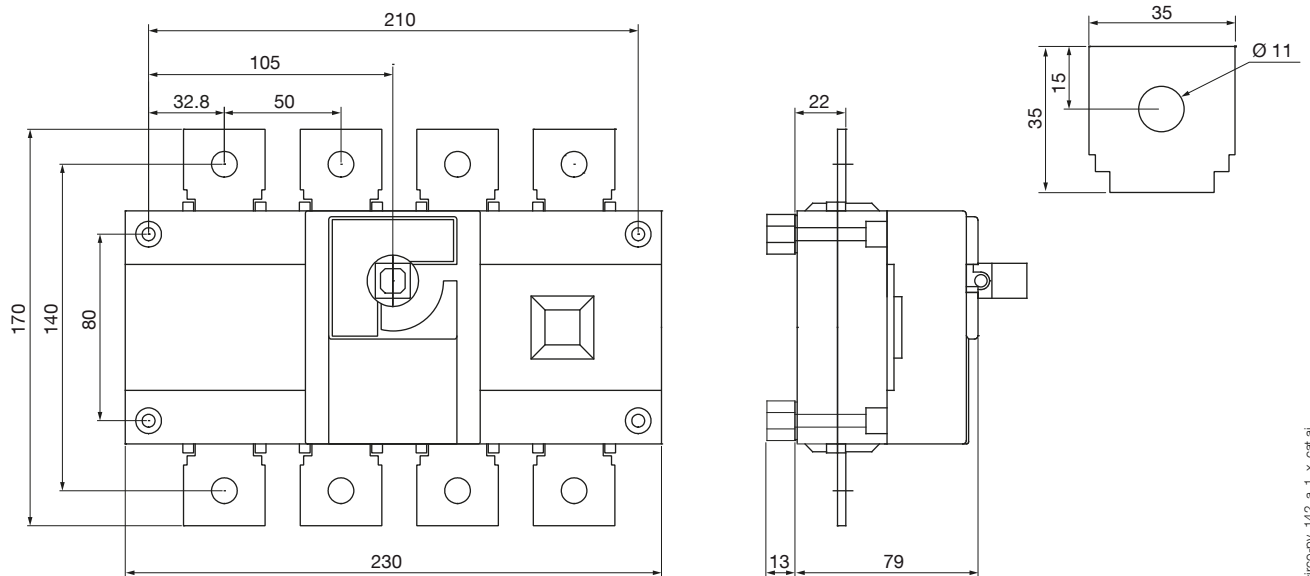

sirco-pv_142_a_1_x_cat.ital

SIRCO PV IEC 60947-3

Load break switches for photovoltaic applications
from 100 to 3200 A, up to 1500 VDC

Dimensions (mm) (continued)

630 to 800 A - B5 - 4P - 1000 VDC - 1 circuit

26PV 4063 - 26PV 4080

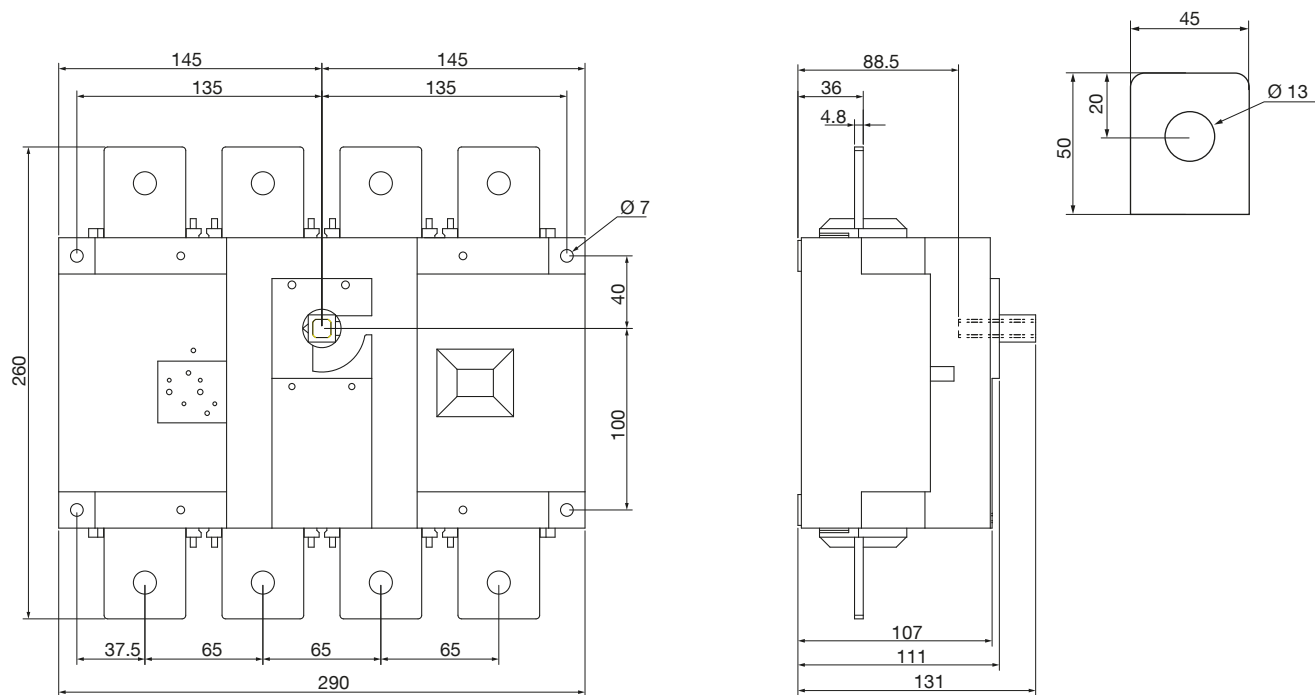

sirco-pv_143_a_1_x_cat.ai

1250 A - B6 - 4P - 1000 VDC - 1 circuit

26PV 4120

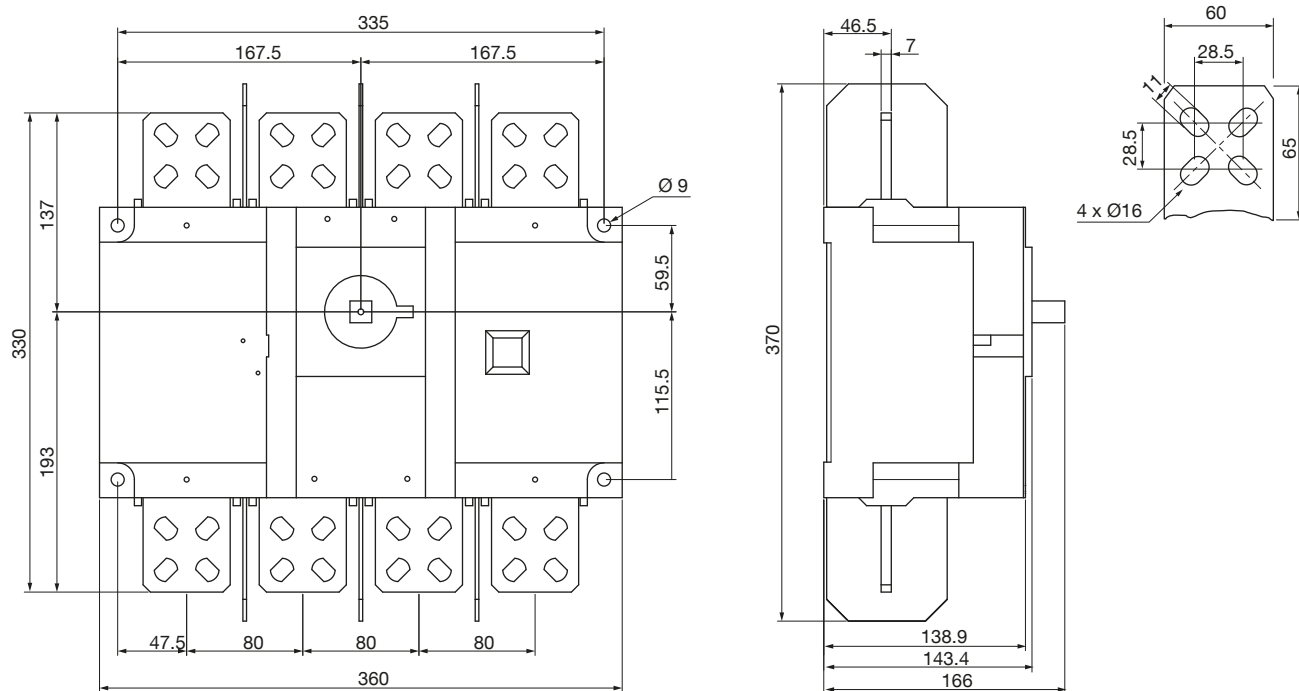

sirco-pv_144_a_1_x_cat.ai

2000 A - B7 - 4P - 1000 VDC - 1 circuit

26PV 4200

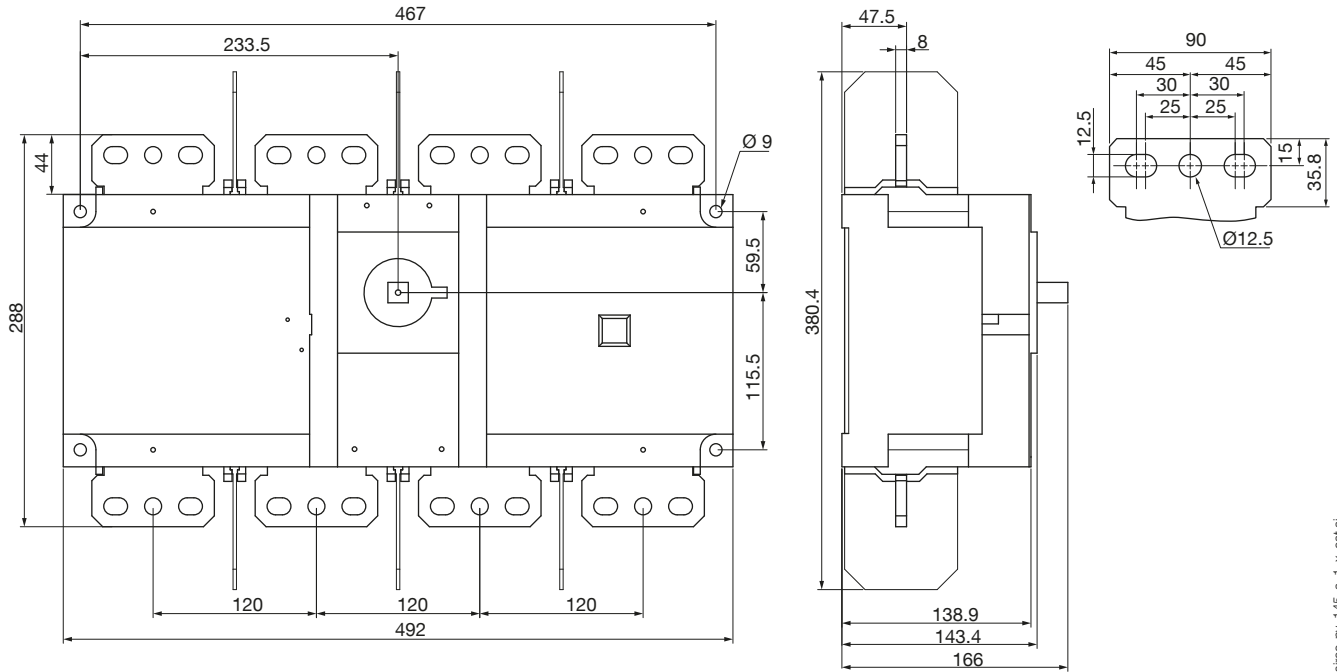

sirco-pv_145_a_1_x_cat.ai

3200 A - B8 - 4P - 1000 VDC - 1 circuit

26PV 4320

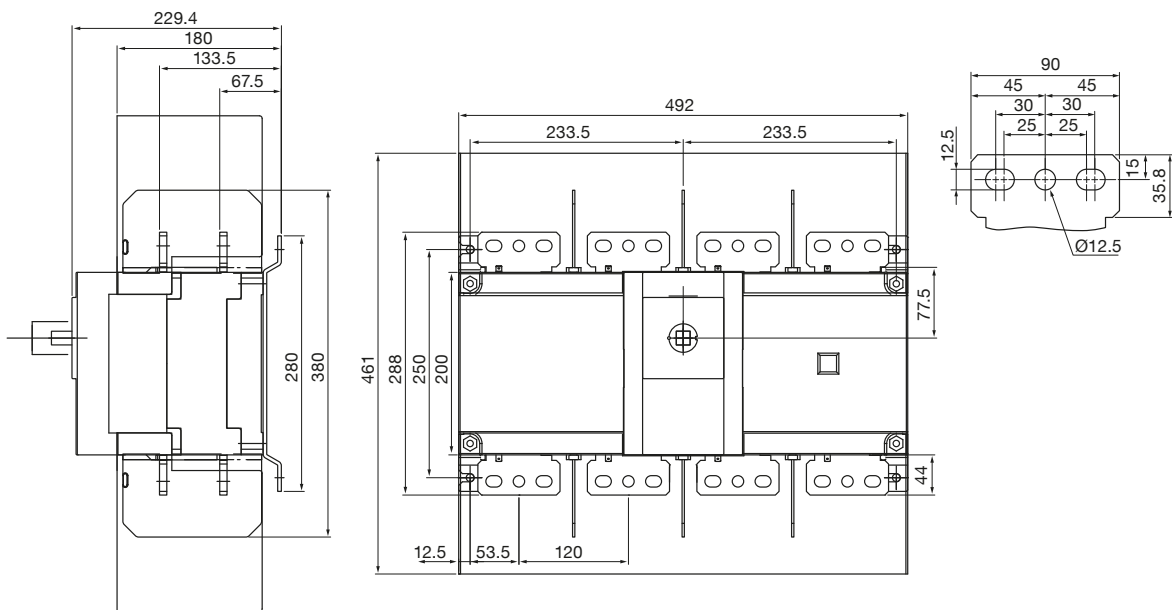

sirco-pv_147_ba_1_x_cat.ai

SIRCO PV IEC 60947-3

Load break switches for photovoltaic applications
from 100 to 3200 A, up to 1500 VDC

Dimensions (mm) (continued)

100 to 315 A - B4_{DS} - 4P - 1000 VDC - 2 circuits

26PV 5010 - 26PV 5016 - 26PV 5025 - 26PV 5031

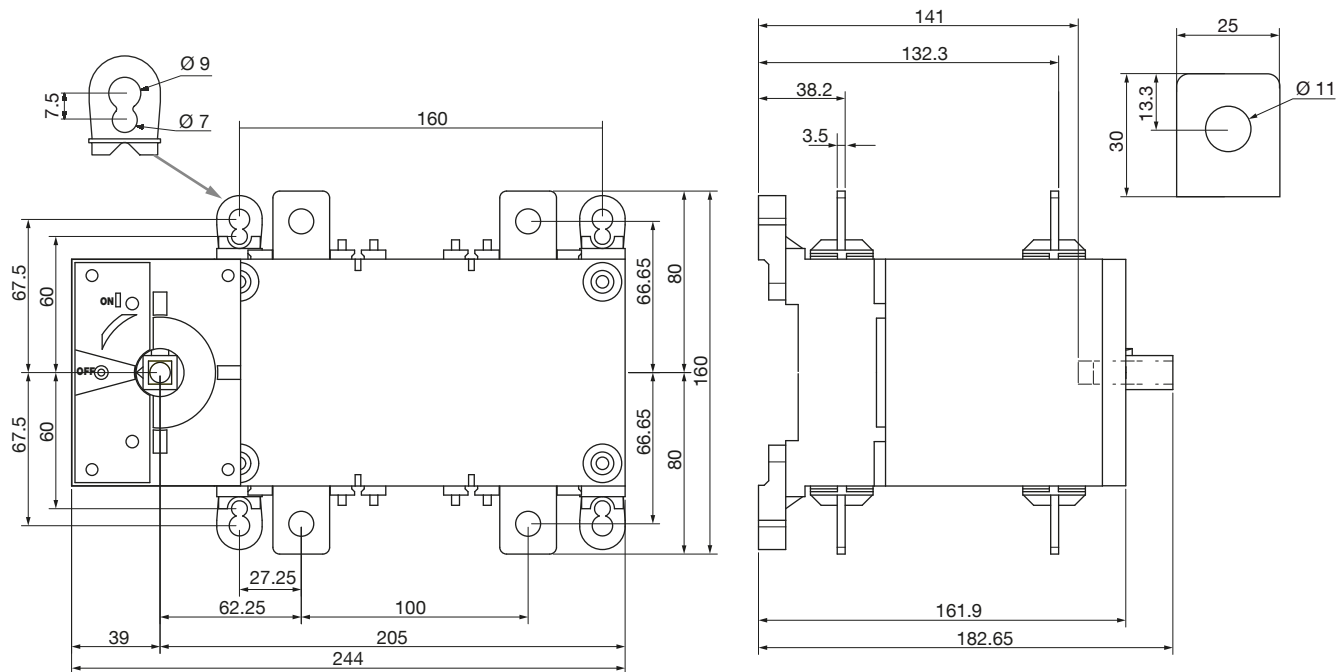

sirco-pv_148_a_1_x_cat.ai

315 to 400 A - B5 - 4P - 1000 VDC - 2 circuits

27PV 4032 - 27PV 4039

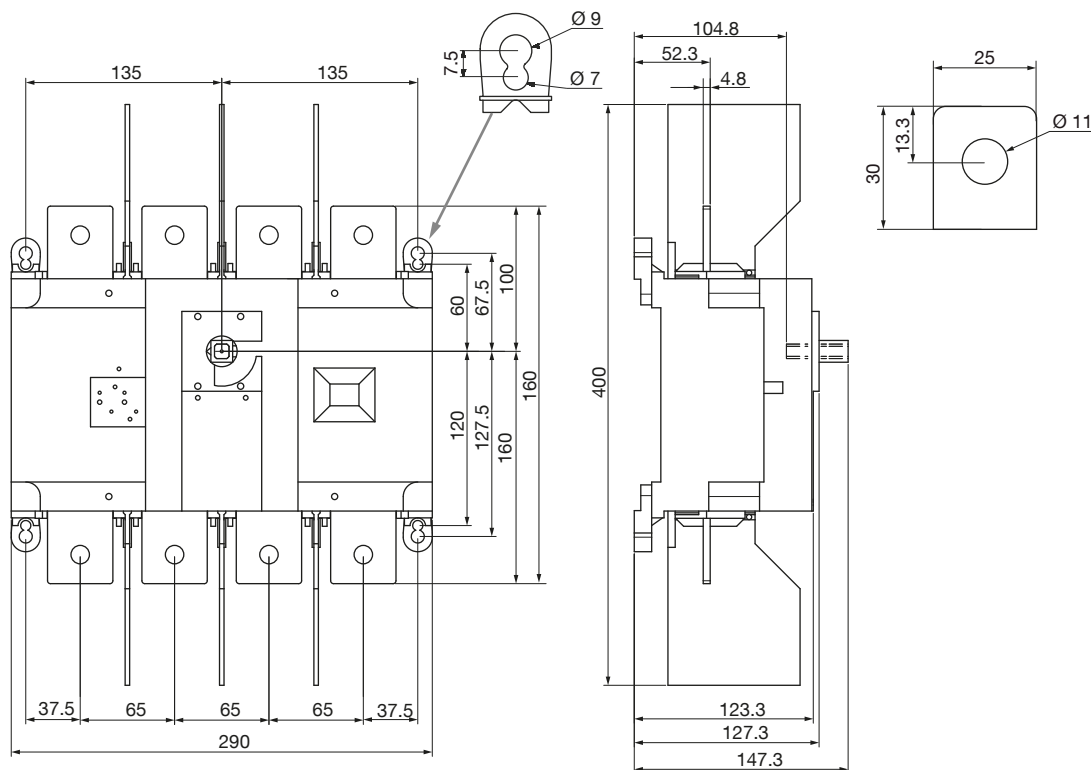

sirco-pv_149_a_1_x_cat.ai

630 A - B5_{DS} - 8P - 1000 VDC - 2 circuits

26PV 8063

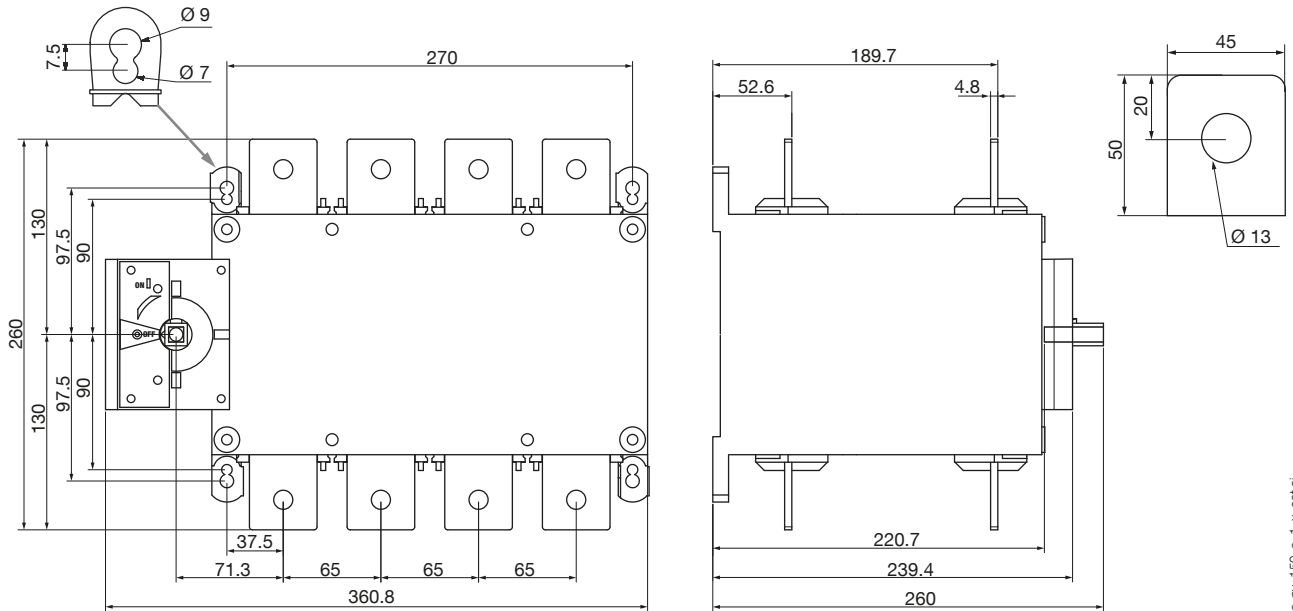

sirco-pv_150_a_1_x_cat.ai

800 A - B6_{DS} - 8P - 1000 VDC - 2 circuits

26PV 8080

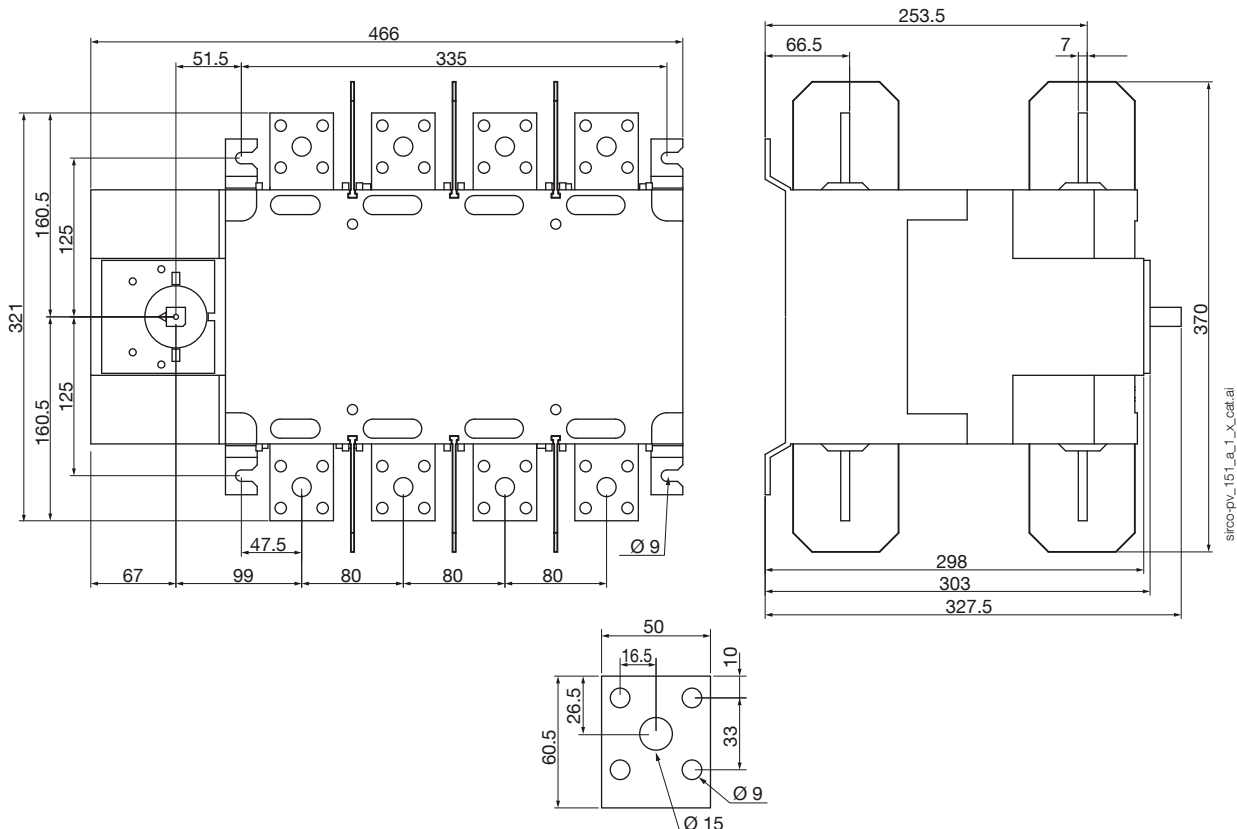

sirco-pv_151_a_1_x_cat.ai

SIRCO PV IEC 60947-3

Load break switches for photovoltaic applications
from 100 to 3200 A, up to 1500 VDC

Dimensions (mm) (continued)

1250 A - B6_{DS} - 8P - 1000 VDC - 2 circuits

26PV 8120

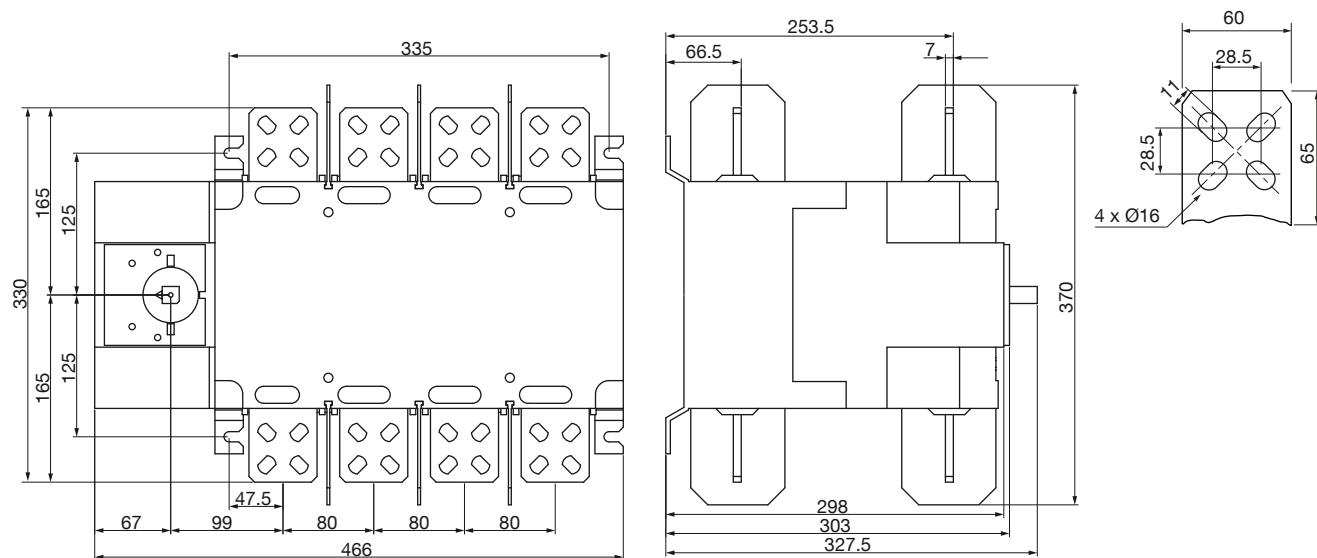

sirco-pv_152_a_1_x_cat.ai

2000 A - B7_{DS} - 8P - 1000 VDC - 2 circuits

26PV 8200

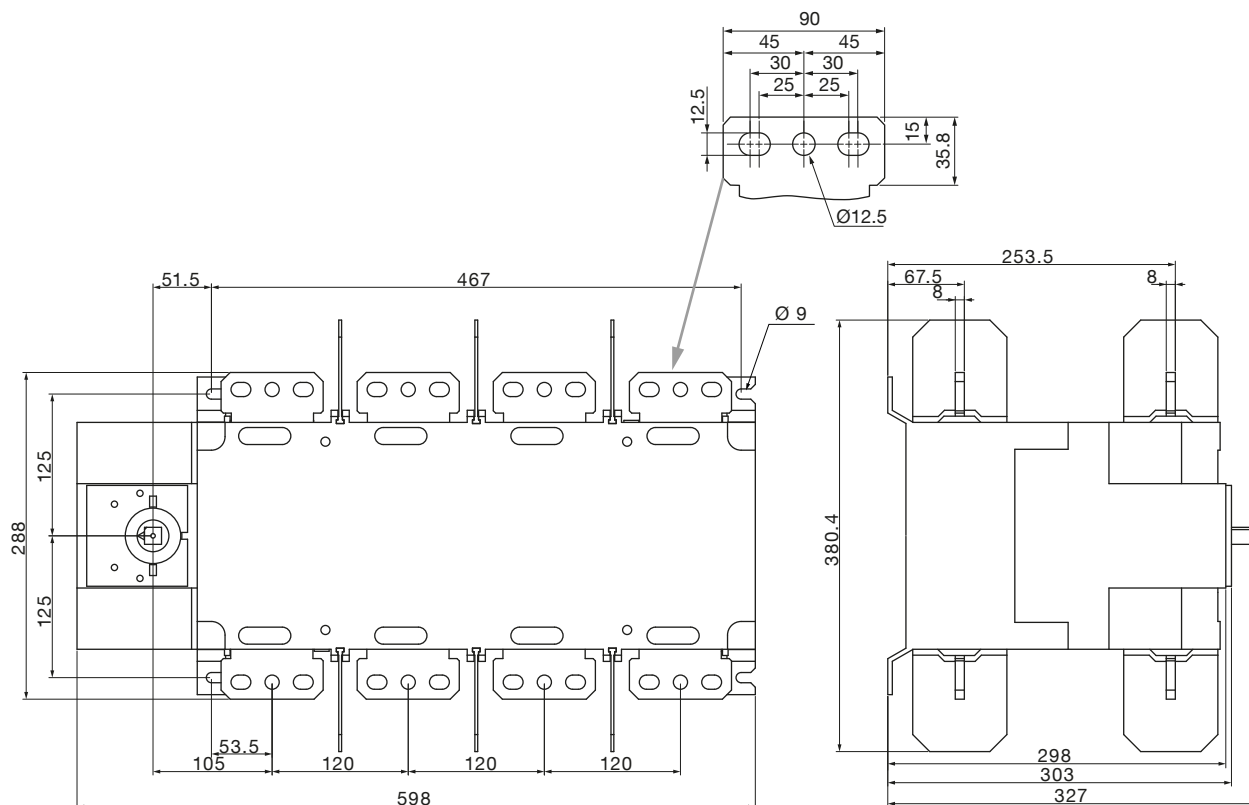

sirco-pv_153_a_1_x_cat.ai

160 to 400 A - B4T - 3P - 1500 VDC - 1 circuit

26PV 3015 - 26PV 3024 - 26PV 3030 - 26PV 3039

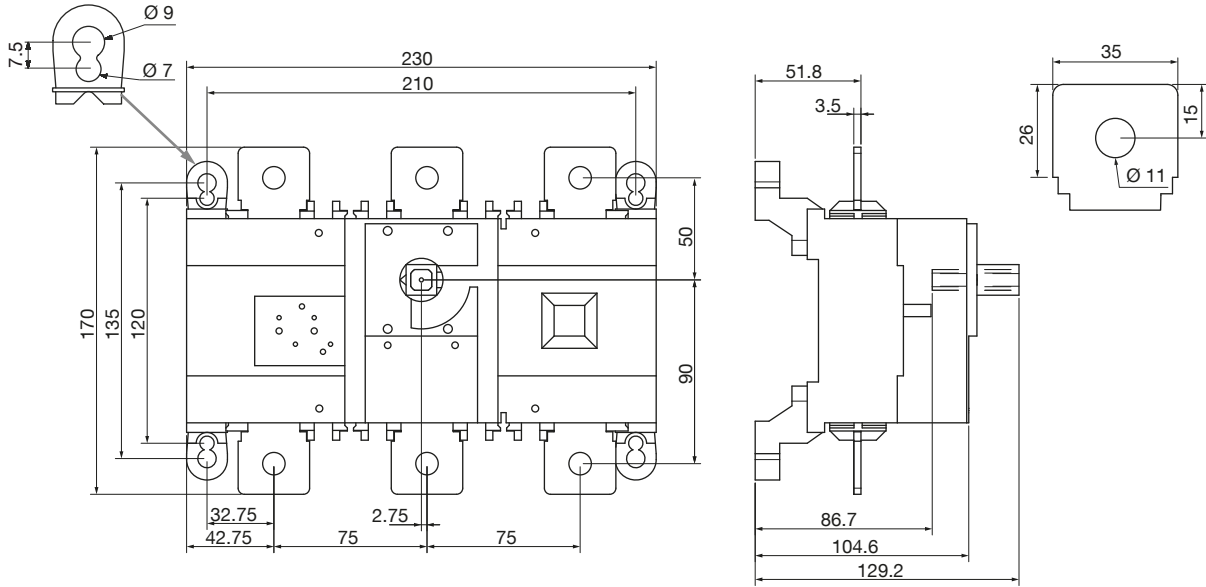

sirco-pv_154_a_1_x_cat.ai

250 to 500 A - B5 - 3P - 1500 VDC - 1 circuit

26PV 3051

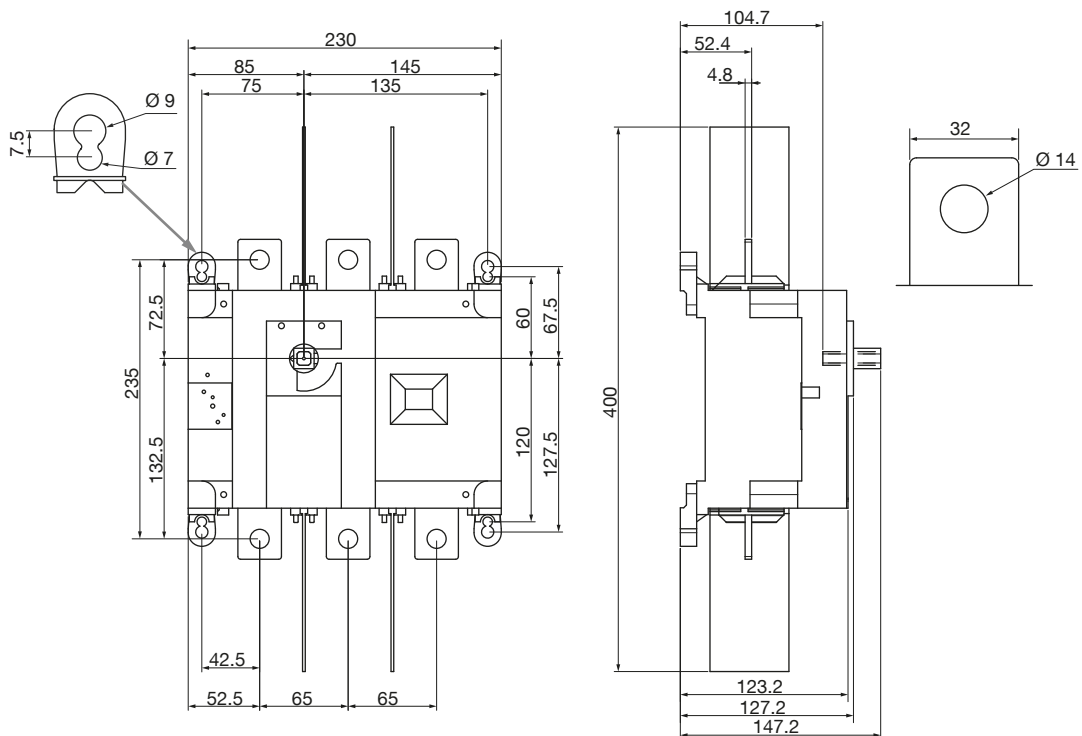

sirco-pv_155_a_1_x_cat.ai

SIRCO PV IEC 60947-3

Load break switches for photovoltaic applications
from 100 to 3200 A, up to 1500 VDC

Dimensions (mm) (continued)

630 A - B5 - 4P - 1500 VDC - 1 circuit

26PV 4064

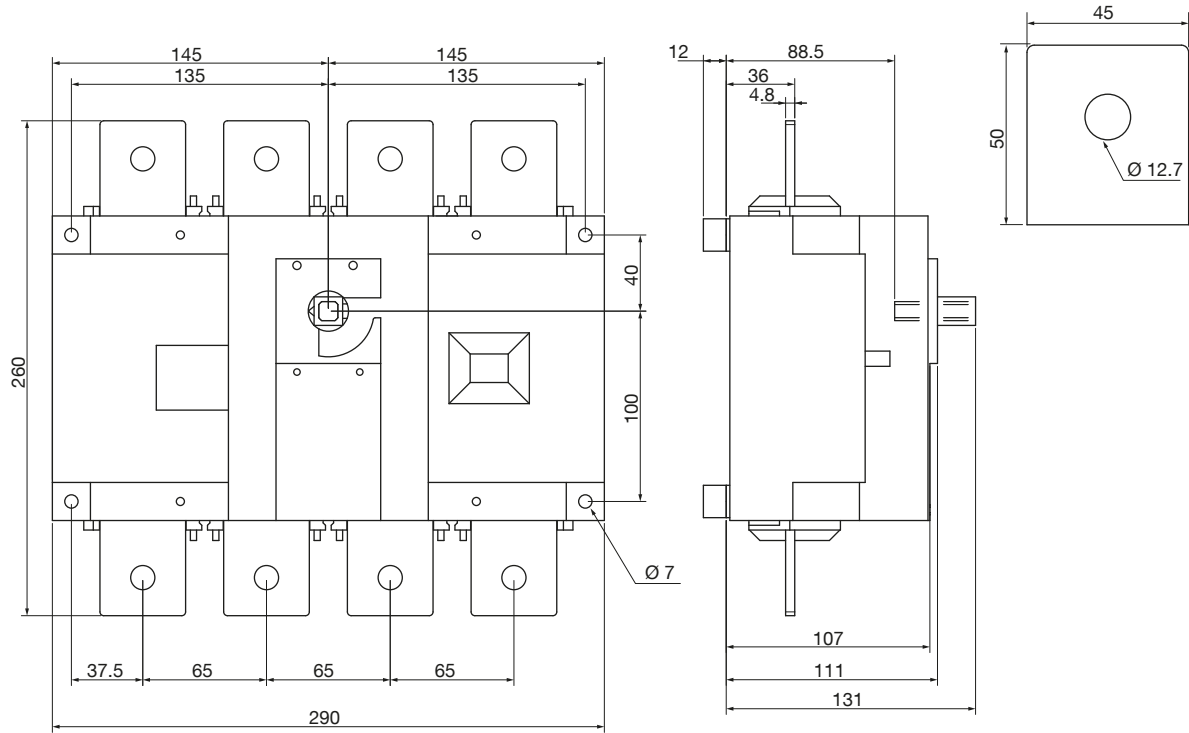

sirco-pv_156_a_1_x_cat.ai

800 A - B6_{DS} - 8P - 1500 VDC - 1 circuit

26PV 8080

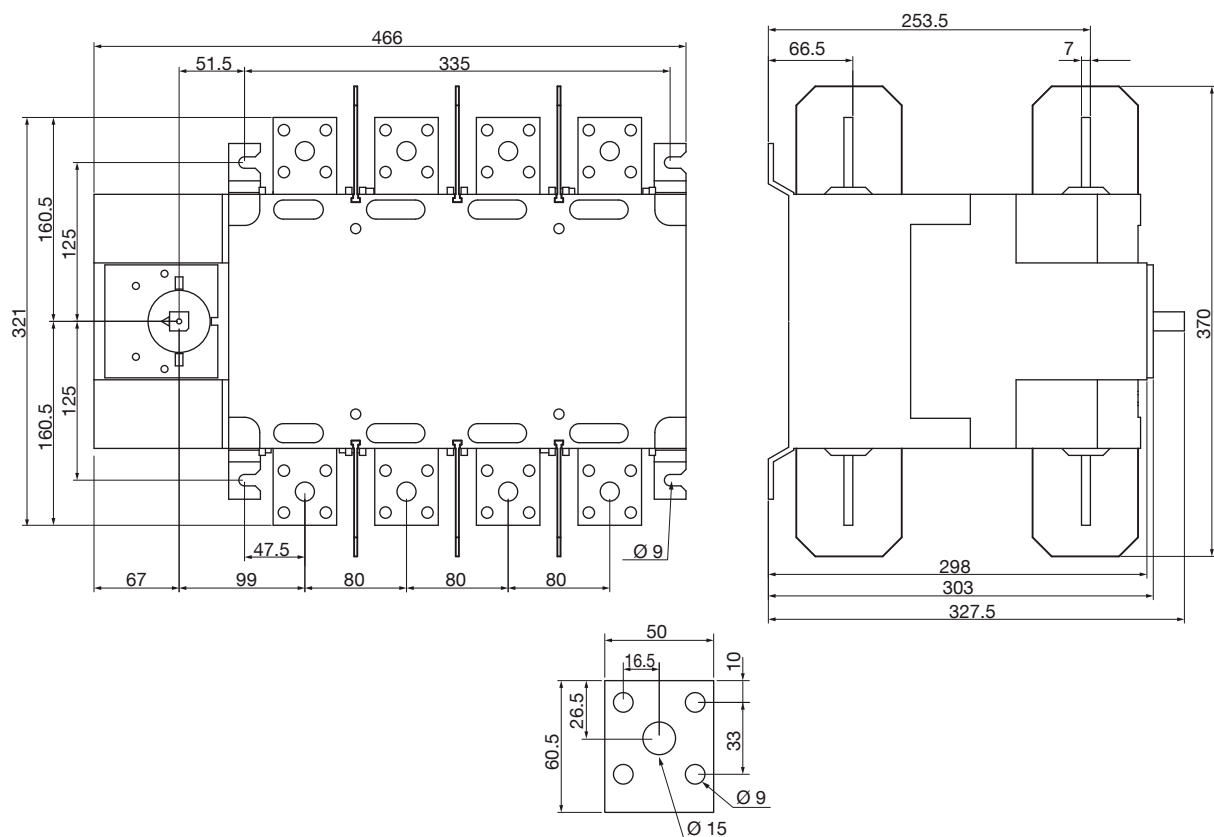

sirco-pv_151_a_1_x_cat.ai

1250 A - B6_{DS} - 8P - 1500 VDC - 1 circuit

26PV 8120

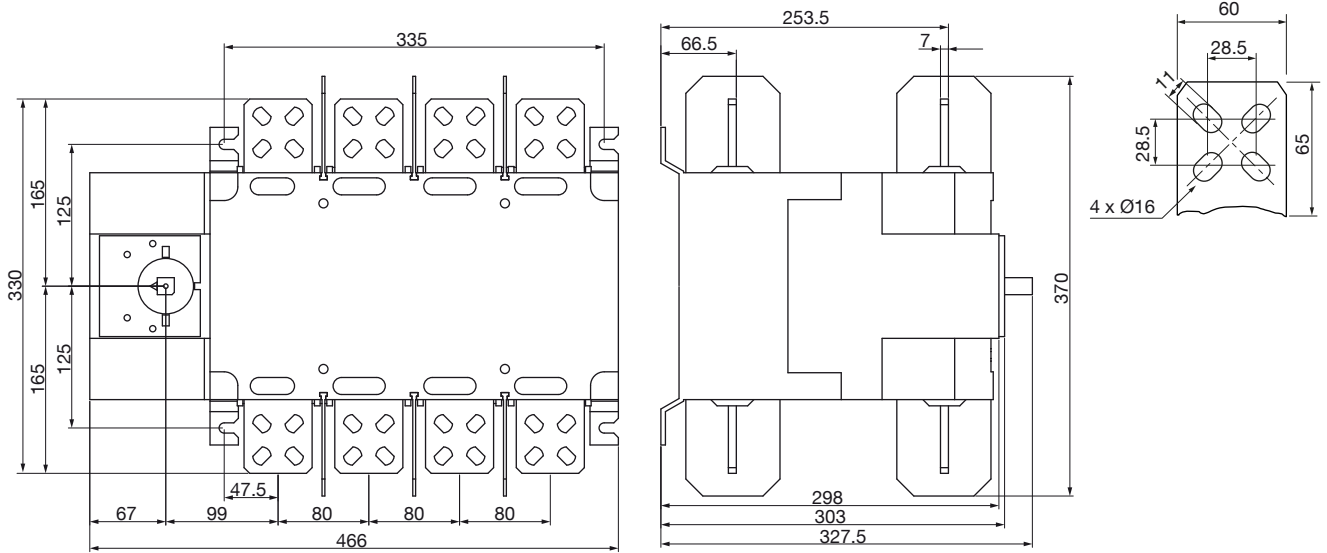

sirco-pv_152_a_1_x_cat.ai

2000 A - B7_{DS} - 8P - 1500 VDC - 1 circuit

26PV 8200

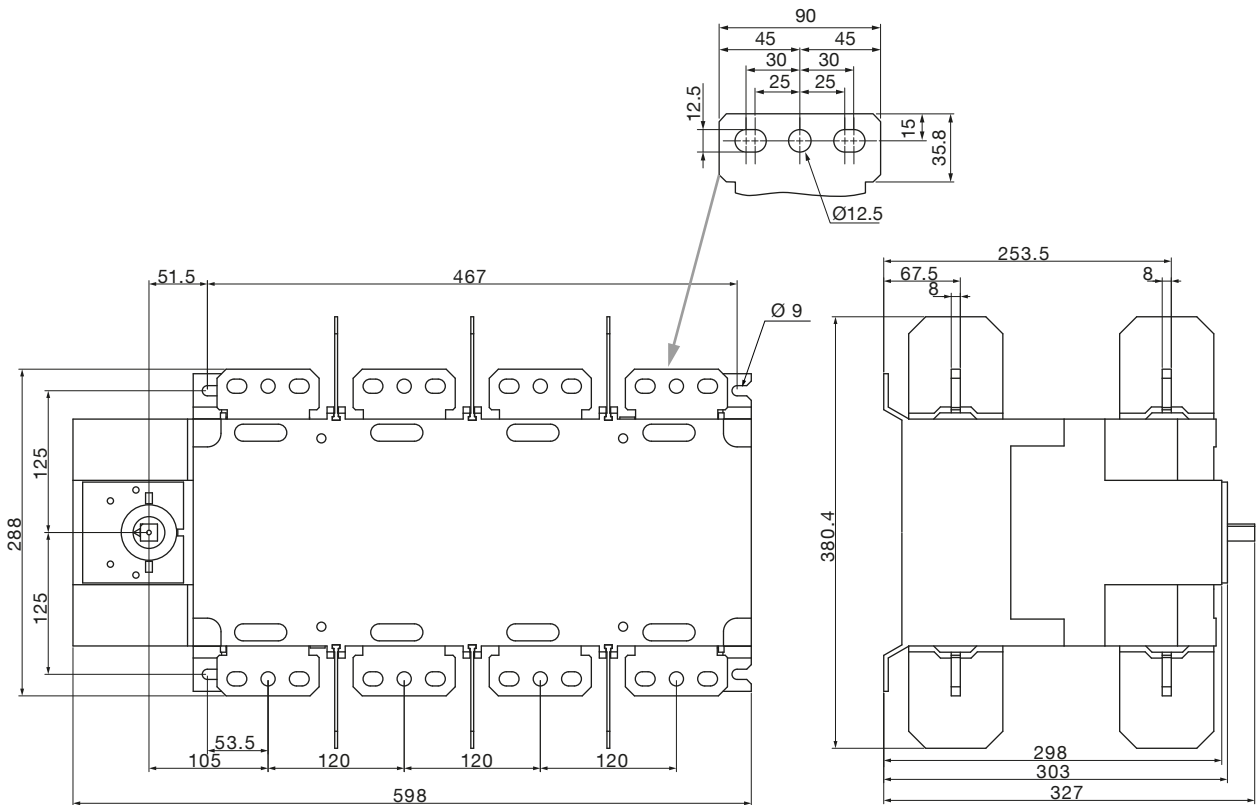

sirco-pv_153_a_1_x_cat.ai

SIRCO PV IEC 60947-3

Load break switches for photovoltaic applications
from 100 to 3200 A, up to 1500 VDC

Dimensions (mm) (continued)

275 to 500 A - B5_{DS} - 6P - 1500 VDC - 2 circuits

26PV 6026 - 26PV 6032 - 26PV 6042 - 26PV 6052

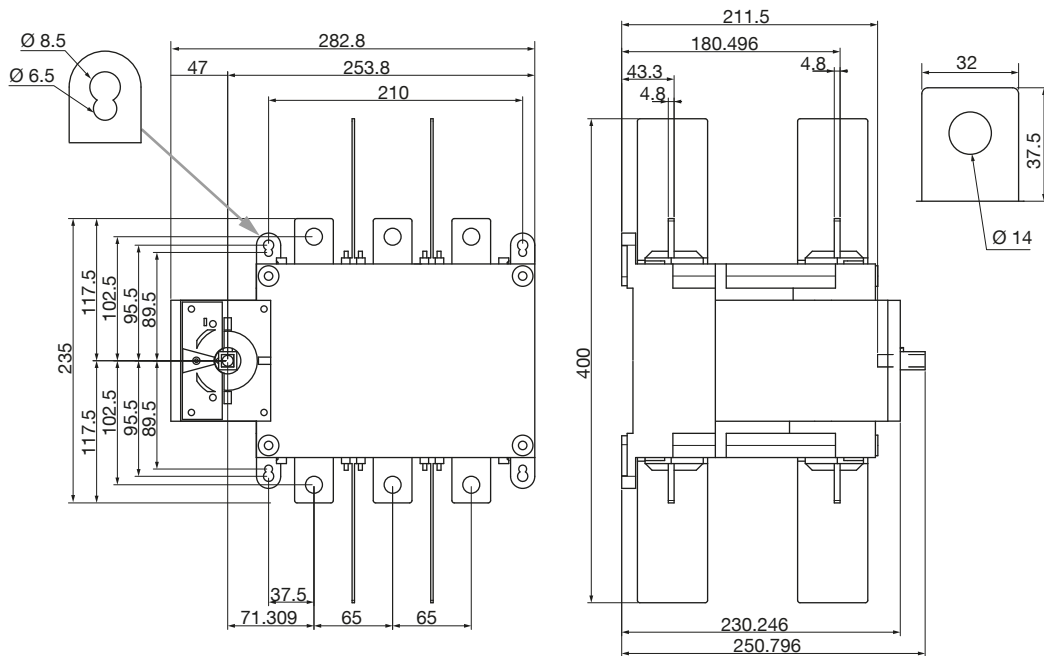

sirco-pv_157_a_1_x_cat.ai

630 A - B5_{DS} - 8P - 1500 VDC - 2 circuits

26PV 8064

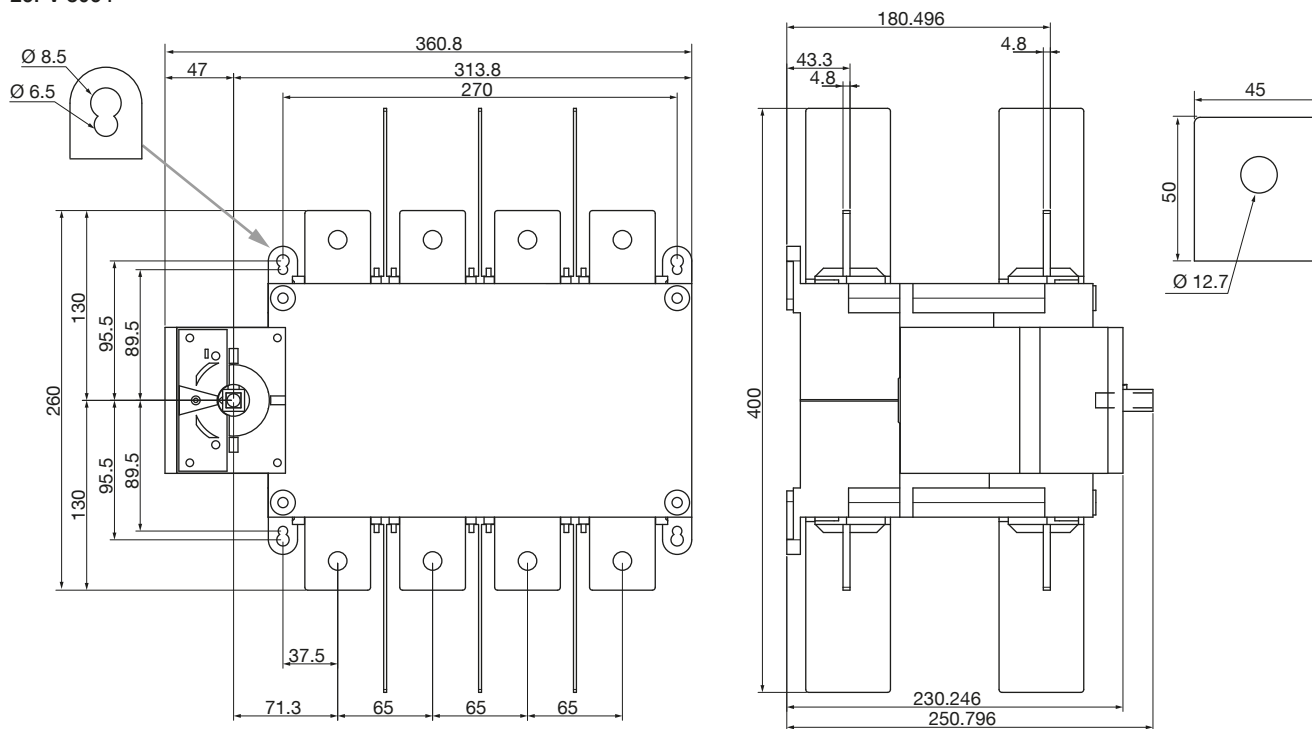

sirco-pv_158_a_1_x_cat.ai

Dimensions for external handles (mm)

B4 - B4_{DS} - B5

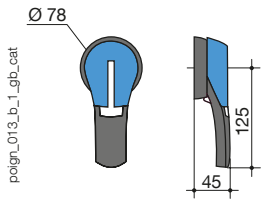
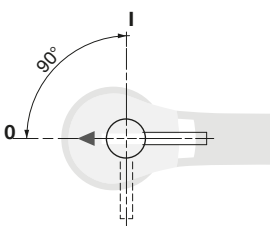
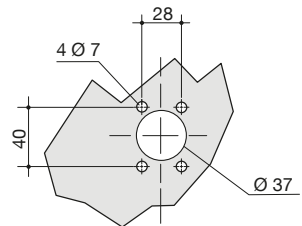
Handle type	Front operation Direction of operation	Door drilling
<p>S2 type</p> <p>poign_013_b_1_gb_cat</p> 		

B5_{DS} - B6 - B7

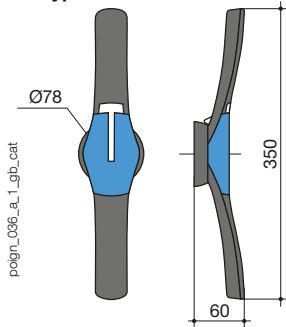
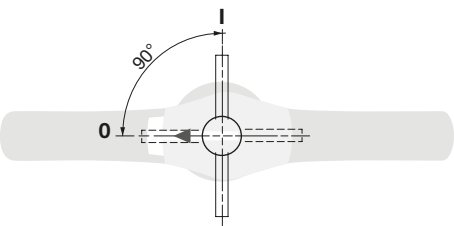
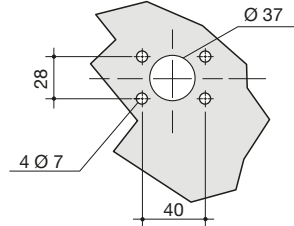
Handle type	Front operation Direction of operation	Door drilling
<p>S4 type</p> <p>poign_036_a_1_gb_cat</p> 		

B8 - B6_{DS} - B7_{DS}

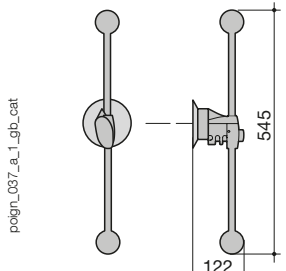
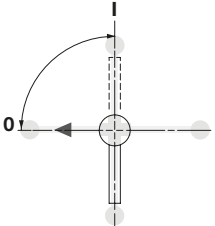
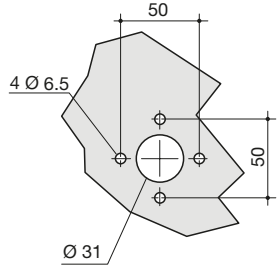
Handle type	Front operation Direction of operation	Door drilling
<p>V1 type</p> <p>poign_037_a_1_gb_cat</p> 		

SIRCO PV IEC 60947-3

Load break switches for photovoltaic applications
from 100 to 3200 A, up to 1500 VDC

Bridging bars (mm)

2609 0025

sirco-ul_030_a_1_x_cat

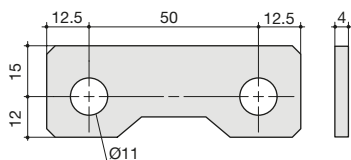

2709 0045

sirco-pv-134_a_1_x_cat

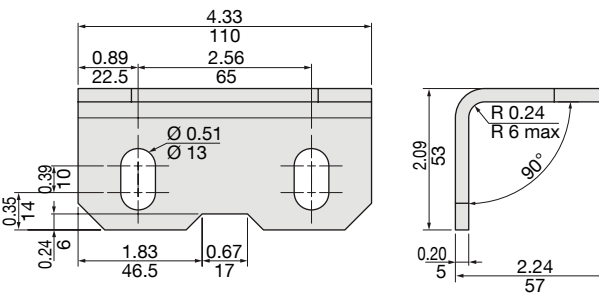

2709 0027

sirco-pv_179_a_1_x_cat

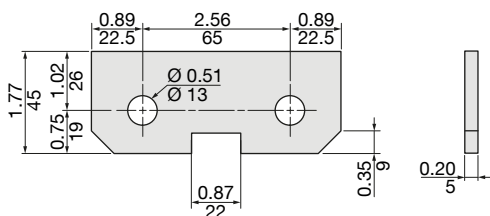

2609 0080

sirco-ul_031_a_1_x_cat

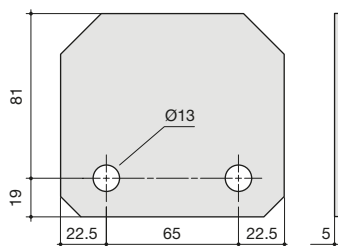

2609 0027

sirco-pv_179_a_1_x_cat

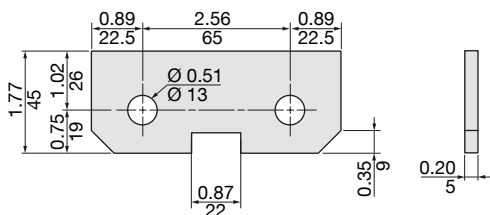

2609 1100

sirco-ul_032_a_1_x_cat

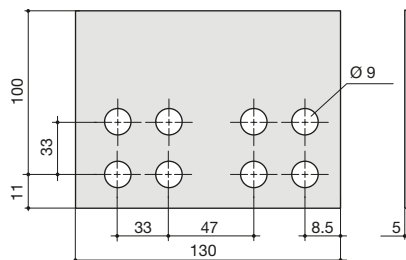

2609 1200

sirco-ul_034_a_1_x_cat

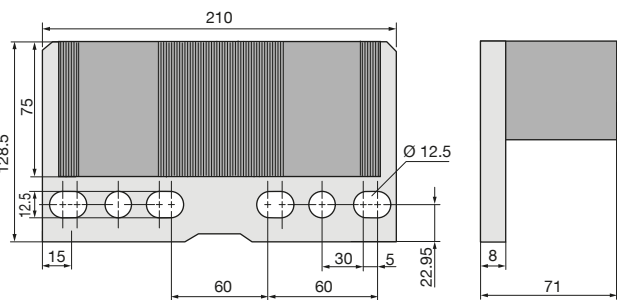

2609 0041

sirco-pv_159_a_1_x_cat

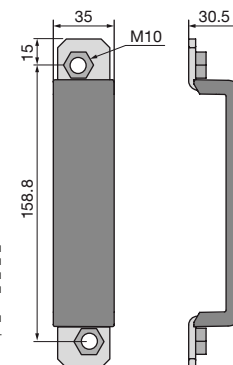

2609 0026

sirco-pv_160_a_1_x_cat

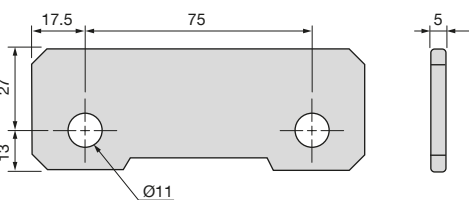

Mounting orientation

B4 to B8

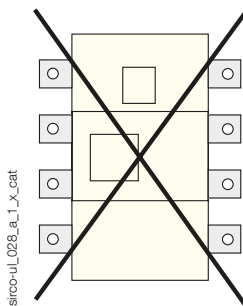
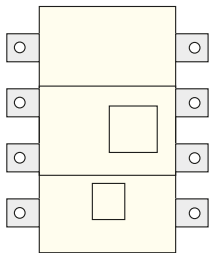
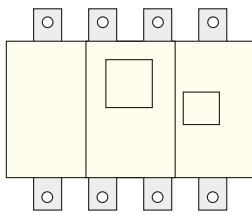
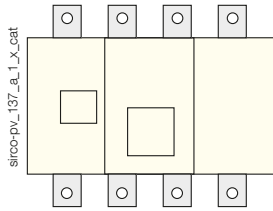

B4_{DS} - B5_{DS}

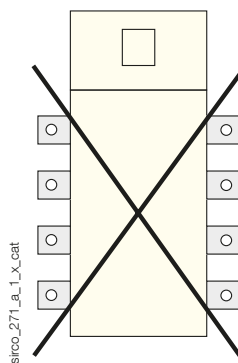
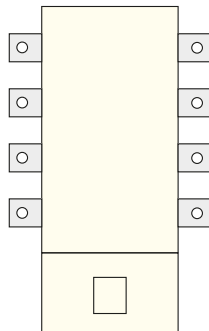
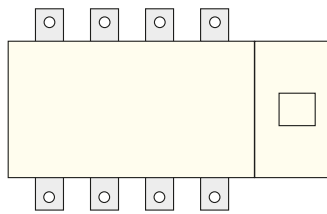
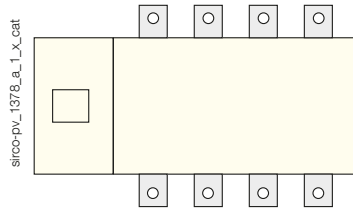

B6_{DS} - B7_{DS}

